



Produktkatalog

Brigitte Branscheid
Industrievertretungen

Im Olpendahl 46
58507 Lüdenscheid
Germany

Tel.: +49 2351 29904
Fax: +49 2351 26471

E-Mail: mail@branscheid.net
www.branscheid.net

Brigitte Branscheid Industrievertretungen liefert: Metallzubehör für alle Industriezweige

Benötigen Sie Rund-, Halb-, Dreieck-, Viereck- oder Trapezringe, Schlaufen, Dorn-, Schiebesteg- und Klemmschnallen, Endkappen, Planösen, Karabinerhaken, Nietknöpfe, etc.?

Brigitte Branscheid Industrievertretungen fertigt Metallbeschläge für jeden Bedarf, auch nach Muster oder Zeichnung.

Dieser Katalog präsentiert Ihnen eine Auswahl unseres umfangreichen Programms. Hinweise unserer weiteren Fertigungssparten erhalten Sie auf den letzten Seiten dieses Katalogs.

Wir verarbeiten Eisen-, Messing- und Leichtmetall-Legierungen aus Draht und Blech. Sämtliche Oberflächenveredlungen werden nach Ihren Wünschen fachgerecht durchgeführt. Ihren Terminvorstellungen werden wir in den meisten Fällen gerecht.

Unsere Preise richten sich nach Bedarf, Material und Qualität. Wir bitten in Ihren Anfragen diese Angaben zu berücksichtigen.

Brigitte Branscheid Industrievertretungen bedankt sich für Ihr Vertrauen. Wir werden es als leistungsfähiger Partner durch schnellste Bedienung würdigen.



Brigitte Branscheid Industrievertretungen supplies: Metal accessories for all industrial branches

Do you require round, half, triangular, square or trapeze rings, tongue, push and clamping buckles, end caps, cross hooks, carbine spring safety hooks, rivet heads, etc.?

Brigitte Branscheid Industrievertretungen manufactures metal fittings for any and all purposes, also in accordance with sample or drawing.

This catalogue contains a selection of our extensive program. Information regarding further production areas may be found on the last page of the catalogue.

We process iron, brass, and light-metal alloys of wire and sheet. All surface treatment is executed in accordance with your very personal requirements.

We are generally in the position to meet specified delivery dates.

Our prices are in accordance with demand, material and quality. We should request you to attend to these factors when ordering.

Brigitte Branscheid Industrievertretungen should like to express thanks for your trust. We shall honour such trust through quick service and efficient partnership.



Brigitte Branscheid Industrievertretungen furnish: Des accessoires métalliques pour toutes les branches de l'industrie

Avez-vous besoin d'anneaux ronds, en demi-cercle, triangulaires, carrés ou en forme de trapèze; de boucles à ardillon, à glissières et à serrage; capuchon d'extrémité, oeillet à surface plane, crochet porte-carabine, tête de rivet, etc.?

Brigitte Branscheid Industrievertretungen exécute des ferrures pour tous besoins et aussi d'après modèle ou dessin.

Ce catalogue vous présente un choix de notre programme étendu. Vous trouverez à la dernière page de ce catalogue des indications concernant nos autres articles.

Nous travaillons des alliages de fer, laiton et métaux légers sous forme de fils et de plaques. Sur demande les surfaces métalliques subissent par nos soins des traitements très variés.

Nous pouvons la plupart du temps répondre à vos désirs concernant les délais de livraison.

Nos prix sont calculés en considération de la quantité, du matériel et de la qualité. Nous vous prions de bien vouloir tenir compte de ces points dans vos demandes.

Brigitte Branscheid Industrievertretungen vous remercie de votre confiance. Nous vous en remercierons encore en vous servant avec perfection et rapidité.



Brigitte Branscheid suministra: accesorios de metal para todos los sectores industriales

¿Necesita Vd. argollas redondas, semicirculares, triangulares, cuadradas, trapezoidales, o hebillas de clavillo, hebillas de trabilla corrediza, hebillas de presión, casquetes, corchetes planos, portacarabinas, cabezas de remaches etc. etc.?

Brigitte Branscheid Industrievertretungen confecciona guarniciones de metal para cada necesidad, también según muestras o diseños.

Este catálogo le muestra a Vd. una selección de nuestro extenso programa. En las últimas páginas encontrará Vd. amplia información acerca de los demás sectores de nuestra confección.

Trabajamos aleaciones de hierro, latón y aluminio de alambre y hojalata. Toda clase de ennoblecimientos superficiales deseados serán llevados a cabo con esmerada perfección.

La mayoría de las veces cumplimos con los plazos de entrega que Vd. propone.

Nuestros precios se amoldan a las necesidades, al material y a la calidad. Les rogamos tengan en cuenta estos datos en sus demandas.

Brigitte Branscheid Industrievertretungen les agradece su confianza, a la que con nuestra eficacia corresponderemos mediante pronto servicio.



02596
i.W. 10,5 mm
φ 1,5 mm



00232
i.W. 16 mm
φ 1,8 mm



00232
i.W. 18 mm
φ 2 mm



00232
i.W. 20 mm
φ 2 mm



00232
i.W. 22 mm
φ 2 mm



0188
i.W. 16 mm
φ 2,5 mm



0188
i.W. 18 mm
φ 2,8 mm



0188
i.W. 20 mm
φ 3 mm



0188
i.W. 23 mm
φ 3,3 mm



0188
i.W. 25 mm
φ 3,5 mm



0188
i.W. 30 mm
φ 3,5 mm



7427
i.W. 30 mm
φ 3 mm



7427
i.W. 35 mm
φ 3 mm

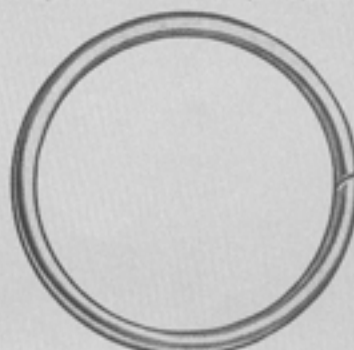

7427
i.W. 40 mm
φ 3 mm



03153
i.W. 35 mm
φ 4,5 mm



02987
i.W. 20 mm
φ 4 mm



02987
i.W. 25 mm
φ 4 mm



02987
i.W. 27 mm
φ 4 mm

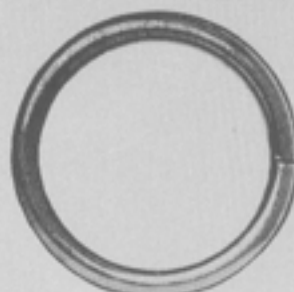

02987
i.W. 30 mm
φ 4 mm

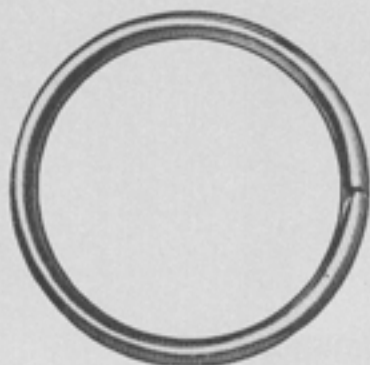

02987
i.W. 40 mm
φ 4 mm

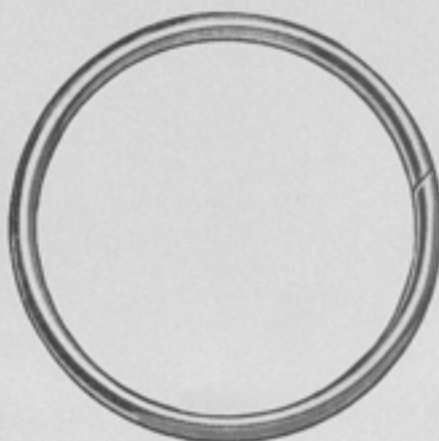

02987
i.W. 50 mm
φ 4 mm

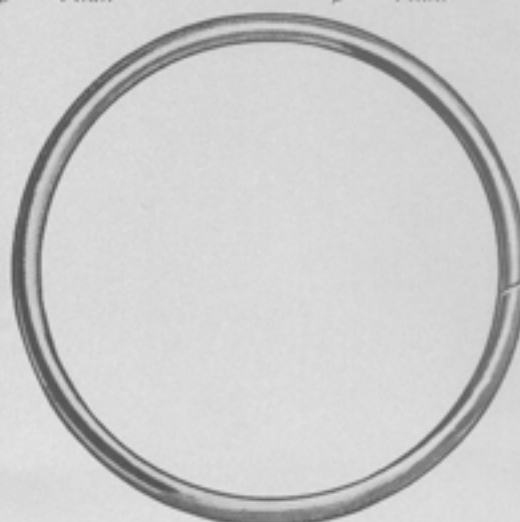

02987
i.W. 60 mm
φ 4 mm



02310
i. W. 30 mm
φ 5 mm



02035 S
02949
i. W. 35 mm
φ 5 mm

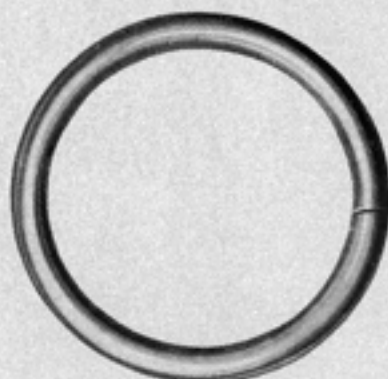

02624
i. w. 40 mm
φ 5 mm



0199
i. W. 8 mm
i. H. 7 mm
φ 1,75 mm



0199
i. W. 10 mm
i. H. 8 mm
φ 2 mm



0199
i. W. 12 mm
i. H. 9 mm
φ 2 mm



0199
i. W. 14 mm
i. H. 10 mm
φ 2,5 mm



0199
i. W. 16 mm
i. H. 12 mm
φ 2,5 mm



0199
i. W. 18 mm
i. H. 14 mm
φ 2,5 mm



0199
i. W. 20 mm
i. H. 16 mm
φ 2,5 mm

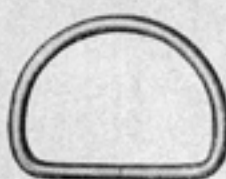

0199
i. W. 22 mm
i. H. 17 mm
φ 2,8 mm



0199
i. W. 25 mm
i. H. 19 mm
φ 3 mm



0199
i. W. 27 mm
i. H. 20 mm
φ 3 mm



0199
i. W. 30 mm
i. H. 23 mm
φ 3,5 mm

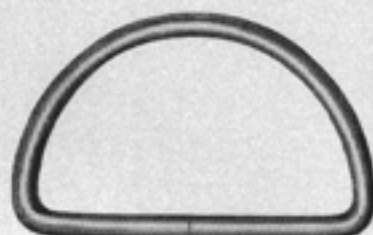

0199
i. W. 40 mm
i. H. 24 mm
φ 3,5 mm
+ φ 3,0 mm



02330
i. W. 22 mm
i. H. 22 mm
φ 3,5 mm



0410 F
i. W. 19 mm
i. H. 19 mm
φ 3,5 mm



0224
02397 D
i. W. 26 mm
i. H. 17 mm
φ 3 mm



0455 B
i. W. 16 mm
i. H. 12 mm
φ 3 mm



0455 A
i. W. 23 mm
i. H. 16 mm
φ 3,5 mm



02593 C
i. W. 22 mm
i. H. 16 mm
φ 3,3 mm



03156
i. W. 21 mm
i. H. 9 mm
φ 3 mm



03156
i. W. 26 mm
i. H. 9 mm
φ 3 mm

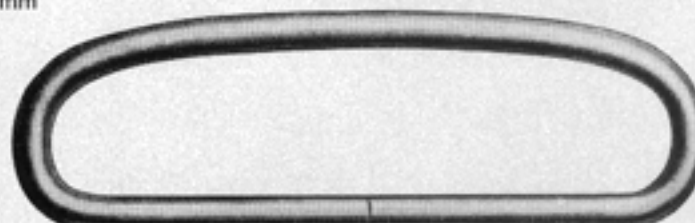

0410 H
i. W. 76 mm
i. H. 19 mm
φ 5 mm



0280 A
i. W. 25 mm
i. H. 17 mm
φ 4 mm



0462 P
i. W. 20 mm
i. H. 16 mm
φ 3,5 mm

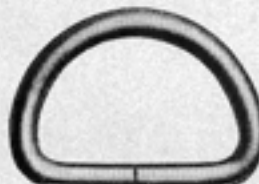

02430 C
i. W. 26 mm
i. H. 17 mm
φ 4 mm

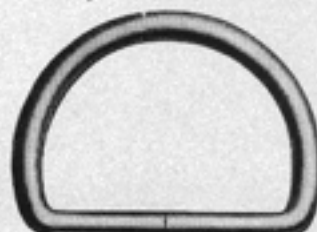

02849
i. W. 32 mm
i. H. 22 mm
φ 4 mm



156
i. W. 18 mm
i. H. 15 mm
φ 2,8 mm



156
i. W. 20 mm
i. H. 16 mm
φ 3 mm



156
i. W. 22 mm
i. H. 17 mm
φ 3 mm



156
i. W. 25 mm
i. H. 18 mm
φ 3,3 mm

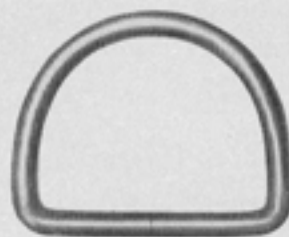

156
i. W. 30 mm
i. H. 23 mm
φ 4 mm

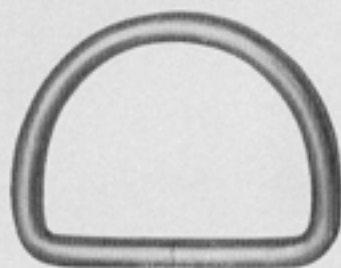

156
i. W. 35 mm
i. H. 24 mm
φ 4,2 mm

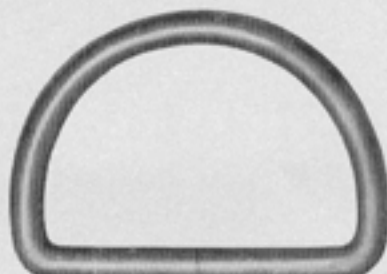

156
i. W. 40 mm
i. H. 27 mm
φ 5 mm



02210
02611 J
i. W. 22 mm
i. H. 19 mm
φ 4 mm



02211
02602 K
i. W. 27 mm
i. H. 22 mm
φ 4,5 mm



02476
i. W. 22 mm
i. H. 22 mm
φ 3,3 mm



02616 E
i. W. 26 mm
i. H. 21 mm
φ 3,3 mm



02655 S
i. W. 22 mm
i. H. 26 mm
φ 4 mm



02035 E
i. W. 18 mm
i. H. 28 mm
φ 4 mm



0453 K
i. W. 25 mm
i. H. 32 mm
φ 5 mm



02847
i. W. 33 mm
i. H. 21 mm
φ 3 mm

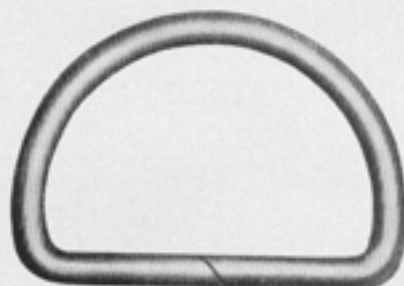

02847
i. W. 42 mm
i. H. 28 mm
φ 4 mm

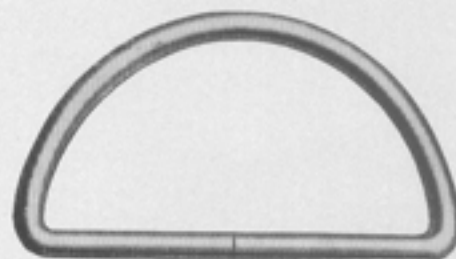

02451 A
i. W. 50 mm
i. H. 26 mm
φ 4 mm

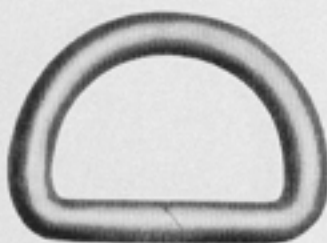

02944 B
i. W. 30 mm
i. H. 20 mm
φ 5,5 mm



02656 B
i. W. 25 mm
i. H. 24 mm
φ 4 mm



02142
02602 H
i. W. 37 mm
i. H. 31 mm
φ 6 mm

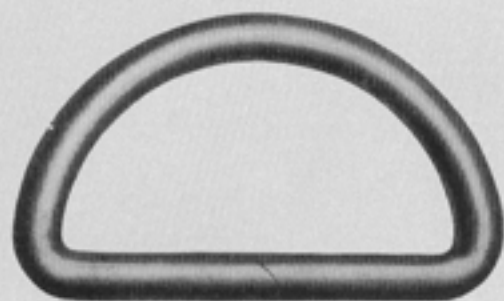

02603
i. W. 50 mm
i. H. 26 mm
φ 6,5 mm

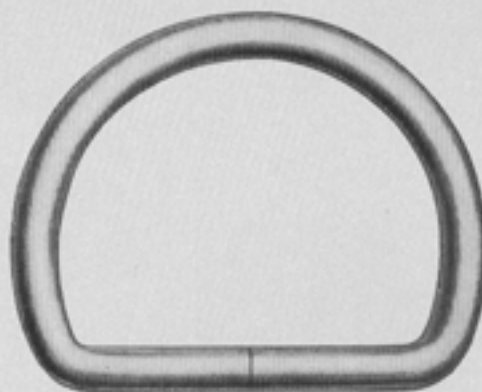

0453 H
i. W. 48 mm
i. H. 38 mm
φ 6 mm



02832
i. W. 25 mm
i. H. 9 mm
φ 2,5 mm



02832
i. W. 30 mm
i. H. 11 mm
φ 3 mm



02832
i. W. 38 mm
i. H. 16 mm
φ 3 mm



02832
i. W. 48 mm
i. H. 20 mm
φ 3 mm



02221
i. W. 34 mm
i. H. 15 mm
φ 3 mm



02221
i. W. 42 mm
i. H. 16 mm
φ 3 mm



02832
i. W. 58 mm
i. H. 23 mm
φ 3 mm



03005
i. W. 20 mm
i. H. 20 mm



03005
i. W. 22 mm
i. H. 20 mm



03005
i. W. 25 mm
i. H. 20 mm



02336
i. W. 56 mm
i. H. 20 mm
φ 3,5 mm



02407
i. W. 12 mm
i. H. 8 mm
φ 2 mm



03024
i. W. 15 mm
i. H. 9 mm
φ 2,5 mm



02816
i. W. 22 mm
i. H. 13 mm
φ 2 mm



02164
i. W. 20 mm
i. H. 15 mm
φ 3 mm



02857
i. W. 30 mm
i. H. 19 mm
φ 2,5 mm

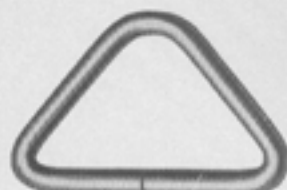

02857
i. W. 30 mm
i. H. 19 mm
φ 3,3 mm



0366
i. W. 23 mm
i. H. 17,5 mm
φ 4 mm



0358
i. W. 23 mm
i. H. 17,5 mm
φ 3,5 mm



02602 C
i. W. 20 mm
i. H. 20 mm
φ 3,5 mm

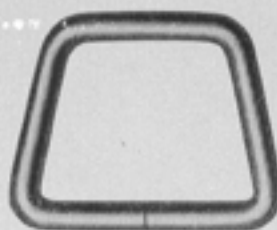

02654 C
i. W. 28,5 mm
i. W. 21 mm
i. H. 22 mm
φ 4 mm



02397 C
i. W. 16,5 mm
i. W. 10,5 mm
i. H. 22 mm
φ 3 mm



0497
i. W. 26 mm
i. W. 12 mm
i. H. 21 mm
φ 3,3 mm



0417
i. W. 18 mm
i. W. 20 mm
i. H. 17 mm
φ 3 mm



02337
i. W. 22 mm
i. W. 19 mm
i. H. 18 mm
φ 3 mm



03013
i. W. 17 mm
i. W. 13 mm
i. H. 22 mm
φ 3 mm



03001
i. W. 20 mm
i. W. 13 mm
i. H. 8 mm
φ 2,5 mm



03001
i. W. 25 mm
i. W. 13 mm
i. H. 9 mm
φ 2,5 mm



03001
i. W. 30 mm
i. H. 8 mm
i. H. 5 mm
φ 2,5 mm



03001
i. W. 35 mm
i. H. 8 mm
i. H. 5 mm
φ 2,5 mm



03001
i. W. 40 mm
i. H. 8 mm
i. H. 5 mm
φ 2,5 mm



03001
i. W. 45 mm
i. H. 8 mm
i. H. 5 mm
φ 2,5 mm



03001
i. W. 50 mm
i. H. 9 mm
i. H. 5 mm
φ 2,5 mm



03133
i. W. 40 mm
i. W. 25 mm
i. H. 21 mm
φ 4 mm



0385
i. W. 20 mm
i. H. 24 mm
φ 3,3 mm



03138
i. W. 21 mm
i. H. 21 mm
φ 4 mm

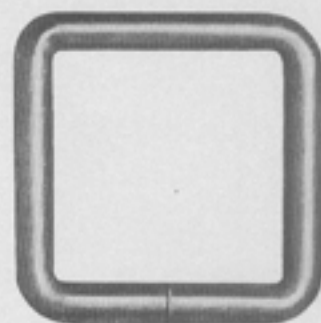

03138
i. W. 31 mm
i. H. 31 mm
φ 5 mm



0407
i. W. 20 mm
i. H. 12 mm
φ 2,5 mm



02920 B
i. W. 21 mm
i. H. 14 mm
φ 4,2 mm



02864 G
i. W. 25 mm
i. H. 15 mm
φ 4,2 mm



03058
25 mm



0363
i. W. 27 mm
i. H. 12 mm
φ 4 mm



02864 J
i. W. 21 mm
i. H. 14 mm
φ 3,4 mm



02925 B
i. W. 26 mm
i. H. 13 mm
φ 4,2 mm



02864 C
i. W. 21 mm
i. H. 18 mm
φ 3,4 mm



0386
i. W. 9,5 mm
i. H. 14 mm
φ 1,75 mm



02473
02655 T
i. W. 21 mm
i. H. 10 mm
φ 3 mm

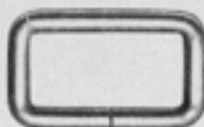

02474
i. W. 22 mm
i. H. 10 mm
φ 3,3 mm



02475
i. W. 22,5 mm
i. H. 13 mm
φ 3,3 mm



02718
i. W. 17,5 mm
i. H. 34 mm
φ 2,5 mm



02472
i. W. 17 mm
i. H. 10 mm
φ 2,8 mm

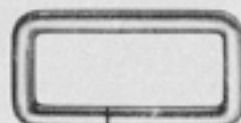

02656 E
i. W. 26 mm
i. H. 10 mm
φ 3 mm

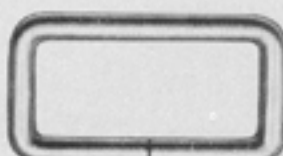

02600
i. W. 31 mm
i. H. 13 mm
φ 4 mm



03060
i. W. 20 mm
i. H. 15 mm
φ 2,5 mm

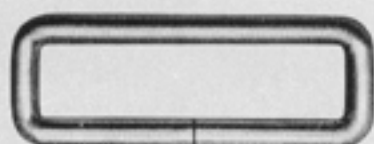

02655 V
02477
i. W. 42 mm
i. H. 10 mm
φ 4 mm

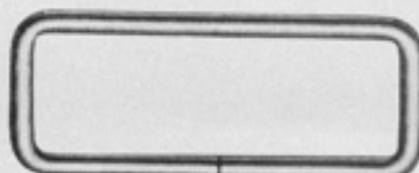

02804
i. W. 50 mm
i. H. 16 mm
φ 3,5 mm

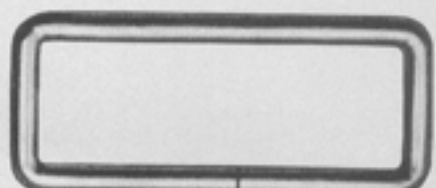

02193
i. W. 51 mm
i. H. 17 mm
φ 4 mm

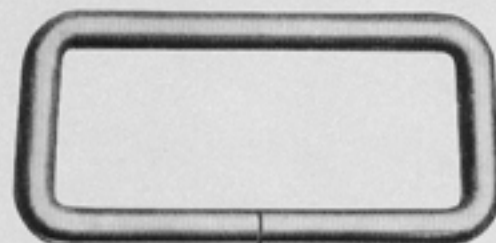

02089 A
i. W. 52 mm
i. H. 20 mm
φ 5,5 mm



03103
i. W. 40 mm
i. H. 20 mm
φ 4 mm

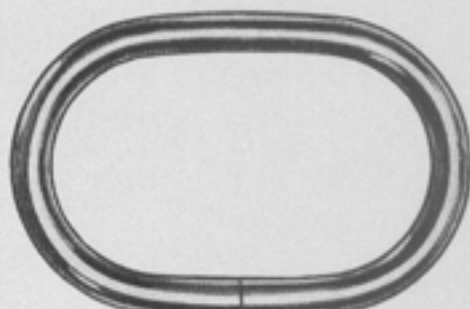

03102
i. W. 50 mm
i. H. 30 mm
φ 5 mm



02978
i. W. 22 mm
i. H. 18 mm



02978
i. W. 24 mm
i. H. 18 mm



03042
i. W. 22 mm
i. H. 18 mm



03017
i. W. 27 mm
i. H. 23 mm

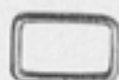

0187
i. W. 12 mm
i. H. 7 mm
∅ 2,80/1,40 mm



0187
i. W. 14 mm
i. H. 8 mm
∅ 2,80/1,40 mm

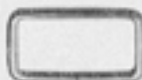

0187
i. W. 16 mm
i. H. 8 mm
∅ 2,80/1,40 mm

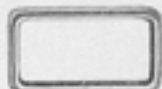

0187
i. W. 18 mm
i. H. 8 mm
∅ 2,80/1,40 mm

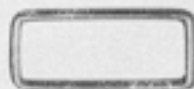

0187
i. W. 20 mm
i. H. 8 mm
∅ 2,80/1,40 mm

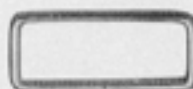

0187
i. W. 22 mm
i. H. 8 mm
∅ 2,80/1,40 mm



0187
i. W. 25 mm
i. H. 8 mm
∅ 2,80/1,40 mm

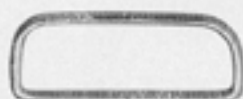

0187
i. W. 27 mm
i. H. 9 mm
∅ 2,80/1,40 mm



0187
i. W. 30 mm
i. H. 10 mm
∅ 3,50/1,75 mm

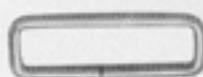

02424
i. W. 24,5 mm
i. H. 6 mm
∅ 2,80/1,40 mm

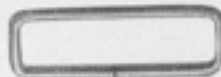

02424
i. W. 27 mm
i. H. 7 mm
∅ 2,80/1,40 mm

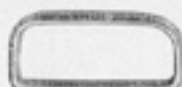

02447
i. W. 21 mm
i. H. 8 mm
∅ 3,90/1,50 mm



02447
i. W. 25 mm
i. H. 8 mm
∅ 3,90/1,50 mm

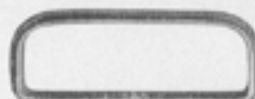

02447
i. W. 30 mm
i. H. 9,5 mm
∅ 3,90/1,50 mm

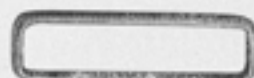

7604
i. W. 30 mm
i. H. 6,5 mm
∅ 3,90/1,50 mm

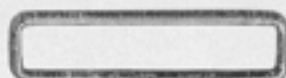

7604
i. W. 35 mm
i. H. 7 mm
∅ 3,90/1,50 mm

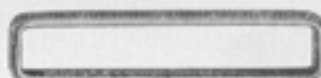

7604
i. W. 40 mm
i. H. 7 mm
∅ 3,90/1,50 mm



7604
i. W. 50 mm
i. H. 7 mm
∅ 3,90/1,50 mm

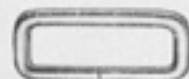

02952 B
i. W. 20 mm
i. H. 5,5 mm
∅ 2,5 mm

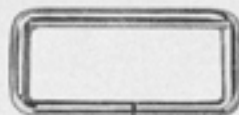

03088
i. W. 25 mm
i. H. 10 mm
∅ 3,50/1,75 mm

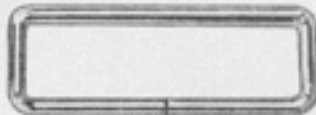

03088
i. W. 35 mm
i. H. 10 mm
∅ 3,50/1,75 mm

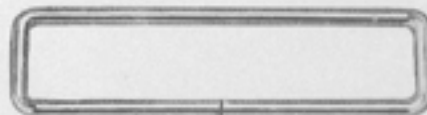

03088
i. W. 50 mm
i. H. 10 mm
∅ 3,50/1,75 mm

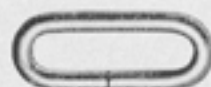

02811
i. W. 21 mm
i. H. 5 mm
∅ 3 mm

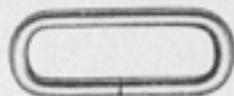

02194
i. W. 25,5 mm
i. H. 7 mm
∅ 2,5 mm



02194
i. W. 25 mm
i. H. 9 mm
∅ 2,5 mm

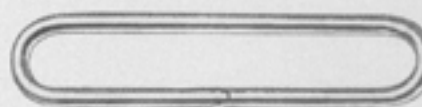

02194
i. W. 50 mm
i. H. 6,5 mm
∅ 3 mm

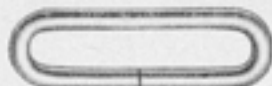

02700 D
i. W. 30 mm
i. H. 5 mm
∅ 3 mm

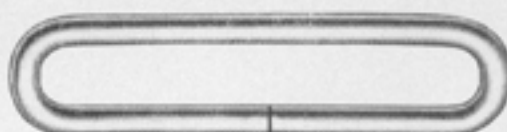

02462 B
i. W. 61,5 mm
i. H. 8 mm
∅ 4,5 mm

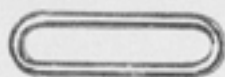

245
i. W. 23 mm
i. H. 5 mm
φ 2 mm

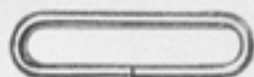

245
i. W. 27 mm
i. H. 5 mm
φ 2 mm

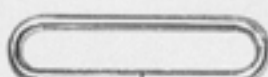

245
i. W. 30 mm
i. H. 5 mm
φ 2 mm

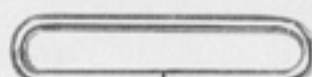

245
i. W. 35 mm
i. H. 5 mm
φ 2 mm

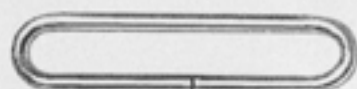

245
i. W. 40 mm
i. H. 6 mm
φ 2,5 mm

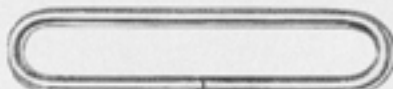

245
i. W. 45 mm
i. H. 6 mm
φ 2,8 mm

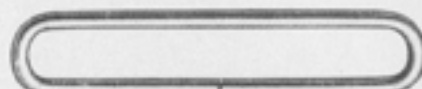

245
i. W. 50 mm
i. H. 7 mm
φ 3 mm



465
i. W. 24 mm
i. H. 15 mm
φ 3 mm



465
i. W. 28 mm
i. H. 16 mm
φ 3,3 mm



465
i. W. 32 mm
i. H. 16 mm
φ 3,3 mm

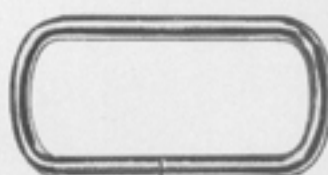

465
i. W. 38 mm
i. H. 16 mm
φ 3,3 mm



465
i. W. 40 mm
i. H. 16 mm
φ 3,5 mm

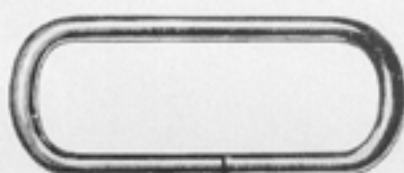

465
i. W. 45 mm
i. H. 16 mm
φ 3,5 mm

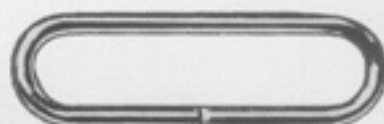

02599
i. W. 40 mm
i. H. 9 mm
φ 3 mm

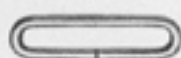

02715
i. W. 21 mm
i. H. 3 mm
φ 1,75 mm

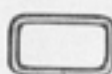

0268
i. W. 10 mm
i. H. 6 mm
φ 1,5 mm



0268
i. W. 12 mm
i. H. 6 mm
φ 1,75 mm

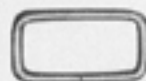

0268
i. W. 14 mm
i. H. 7 mm
φ 1,75 mm

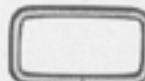

0268
i. W. 16 mm
i. H. 7 mm
φ 1,75 mm

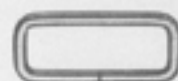

02917 B
i. W. 19,5 mm
i. H. 6 mm
φ 2 mm

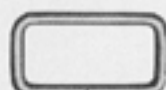

0341
i. W. 18 mm
i. H. 8 mm
φ 2 mm

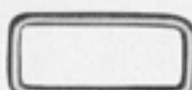

0341
i. W. 20 mm
i. H. 8 mm
φ 2 mm

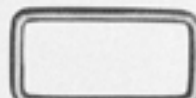

0341
i. W. 22 mm
i. H. 8 mm
φ 2 mm

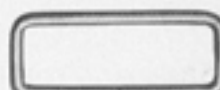

0341
i. W. 25 mm
i. H. 8 mm
φ 2 mm

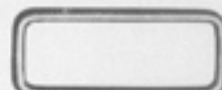

0341
i. W. 27 mm
i. H. 8 mm
φ 2 mm

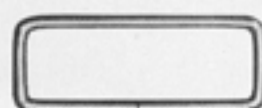

0341
i. W. 30 mm
i. H. 9 mm
φ 2 mm

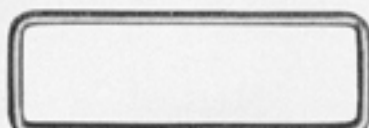

0341
i. W. 43 mm
i. H. 13 mm
φ 2 mm

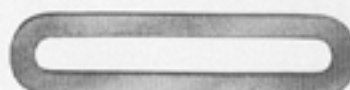

0854 C
i. W. 40 mm
i. H. 4,5 mm

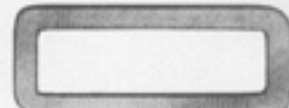

0454 B
i. W. 31 mm
i. H. 8 mm



0376
16 mm

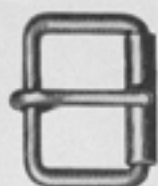

0376
18 mm

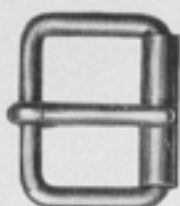

0376
20 mm

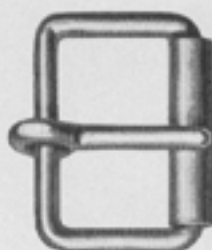

0376
25 mm

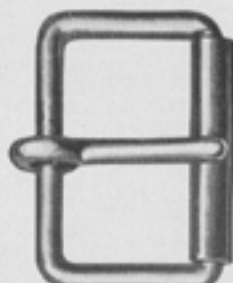

0376
30 mm

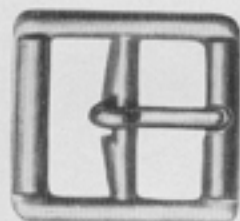

02913
20 mm



0441 A
15 mm



0150
20 mm

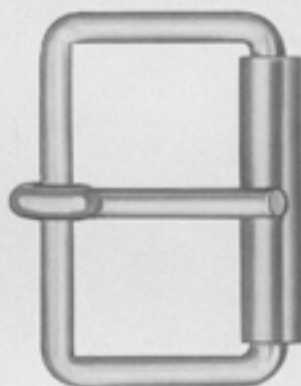

0376
40 mm

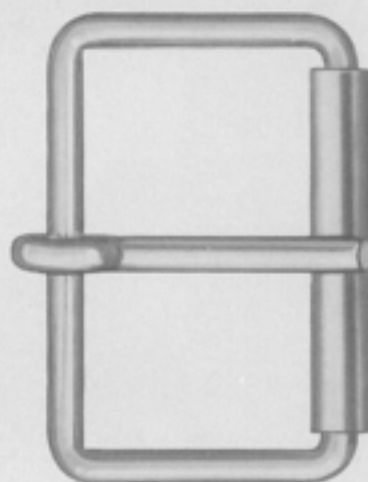

0376
50 mm



02247
16 mm



02247
18 mm

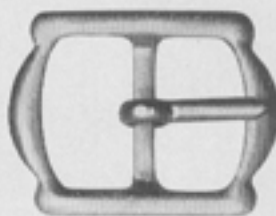

02247
20 mm

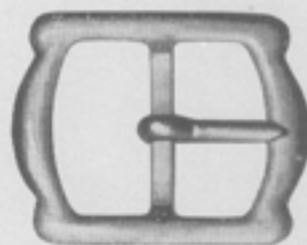

02247
22,5 mm

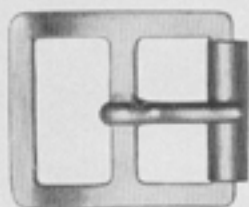

02227
19 mm

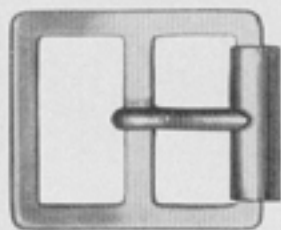

02228
22 mm

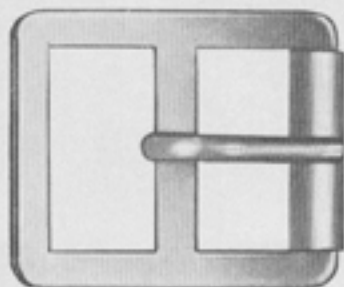

02228
26 mm

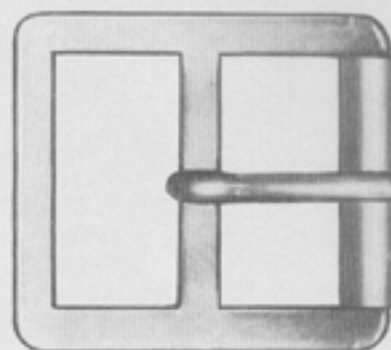

02228
32 mm

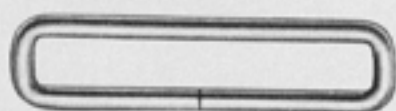

02719 D
i. W. 47 mm
i. H. 6 mm
φ 3,3 mm

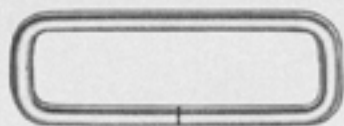

02846
i. W. 40 mm
i. H. 10 mm
φ 3 mm

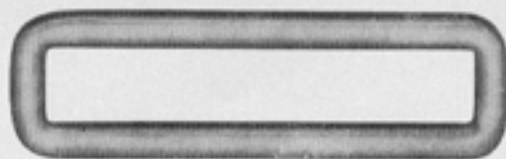

02777
i. W. 59 mm
i. H. 9,5 mm
φ 4 mm

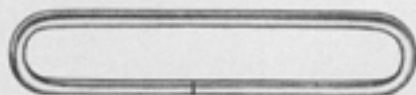

02616 C
i. W. 52 mm
i. H. 7 mm
φ 2,5 mm

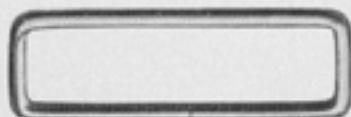

02478
i. W. 42 mm
i. H. 10 mm
φ 4,60/2,40 mm



02397 E
i. W. 28 mm
i. H. 11 mm
φ 3 mm

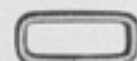

02419 A
i. W. 13 mm
i. H. 4 mm
φ 1,75 mm

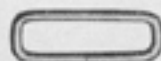

02419 A
i. W. 17 mm
i. H. 4 mm
φ 1,75 mm

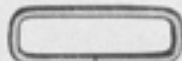

02419 A
i. W. 20 mm
i. H. 5 mm
φ 1,75 mm

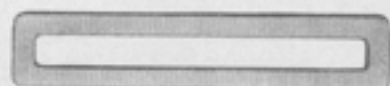

0373
i. W. 45 mm
i. H. 3,5 mm



03344
i. W. 51 mm
i. H. 26,5 mm
φ 4 mm



03214
i. W. 28 mm
i. H. 20 mm
φ 4 mm



03213



03212 A

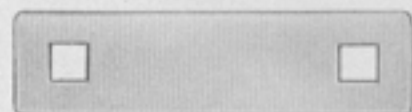

03212 B



02692
75 mm

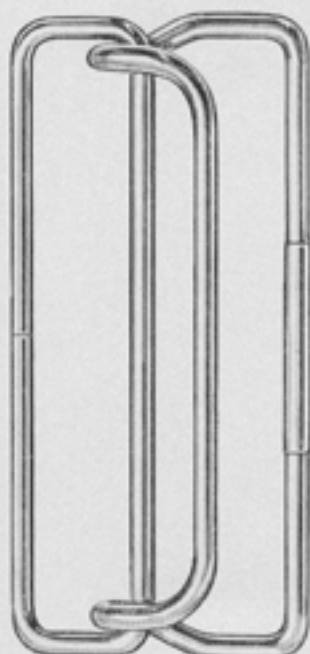

02691
75 mm



02692
50 mm



02691
50 mm



0298
16 mm



00300
16 mm



00300
18 mm



00300
20 mm



00300
22 mm



02716
21 mm

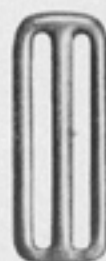

0496
30 mm



0354 B
16 mm



0483 B
20 mm



03351
26 mm



02536
25 mm



02120 E
20 mm



02276
25 mm



02457
25 mm



0454 A
30 mm



02964
35 mm

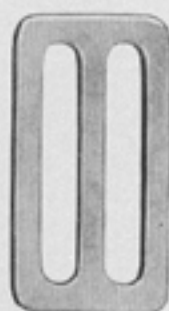

02784
32 mm



02899 B
32 mm



03203 C
35 mm



0854 B
40 mm



02037 A
50 mm



0842 A
33 mm

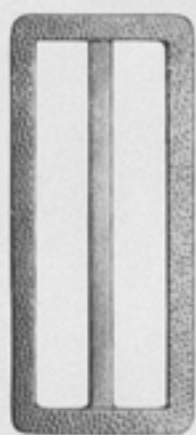

0840 B
50 mm

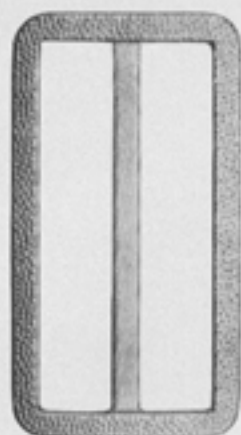

0841 B
50 mm

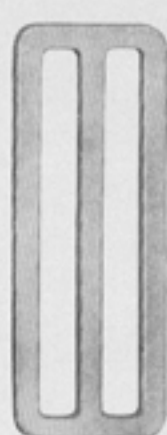

02616 B
50 mm



0804 B
52 mm

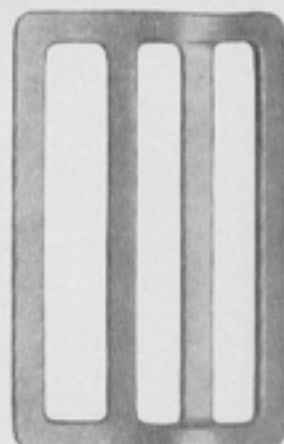

02775
53 mm

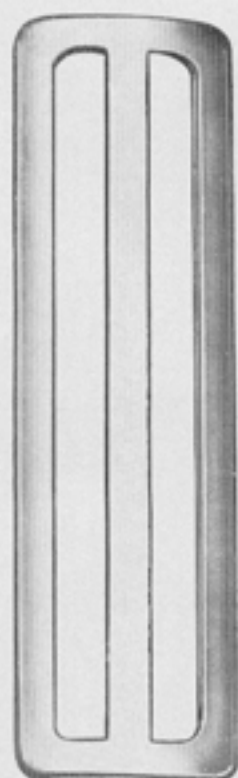

03147
80 mm

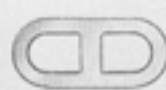

03100 B
5 mm



03031
12 mm



03032
12 mm



03217
30 mm

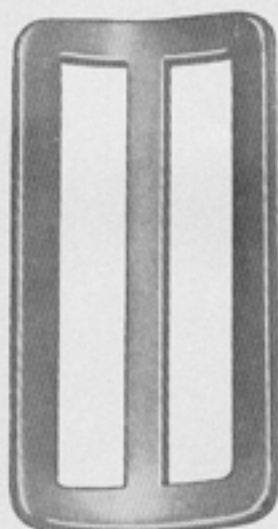

02438
50 mm

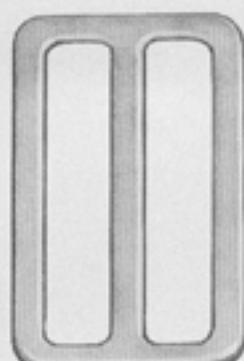

02441
40 mm

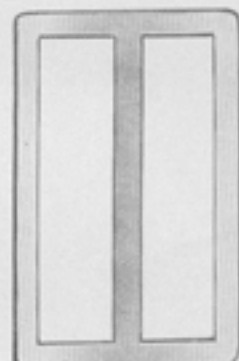

03130
40 mm



03158
40 mm

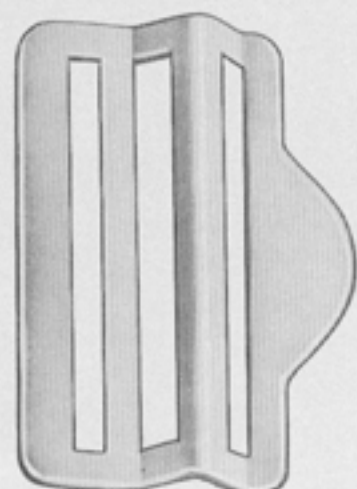

03160
50 mm

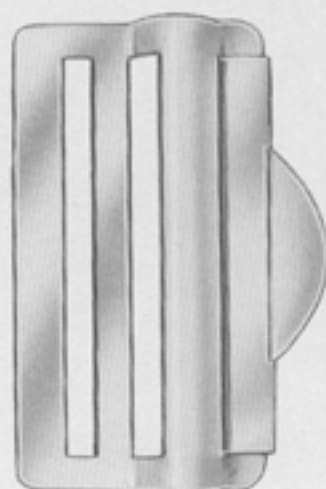

03234
50 mm



03233
50 mm
V 2 A



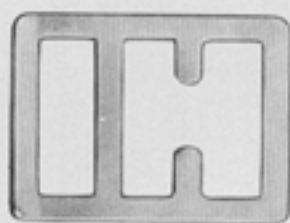

02867 A
21 mm



02655 R
02941
21 mm



02655 O
02430 H
26 mm



02430 D
40 mm



02430 A
50 mm

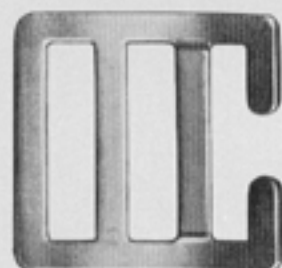

02726
26 mm

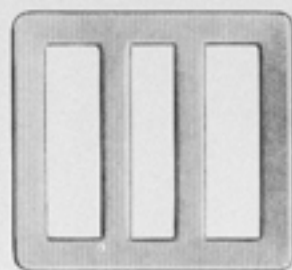

02870
26 mm

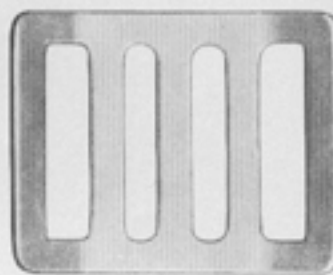

02873
26 mm



02783
32 mm



02807
15 mm



02842
16 mm



02876
26 mm

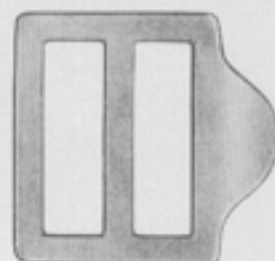

02812
26 mm

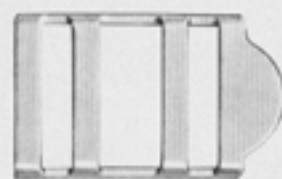

02674 A
20 mm



02388
17 mm



02388
26 mm

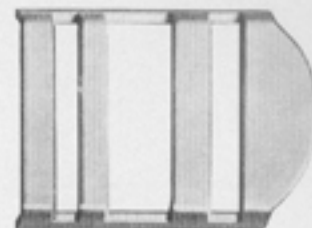

02527
26 mm

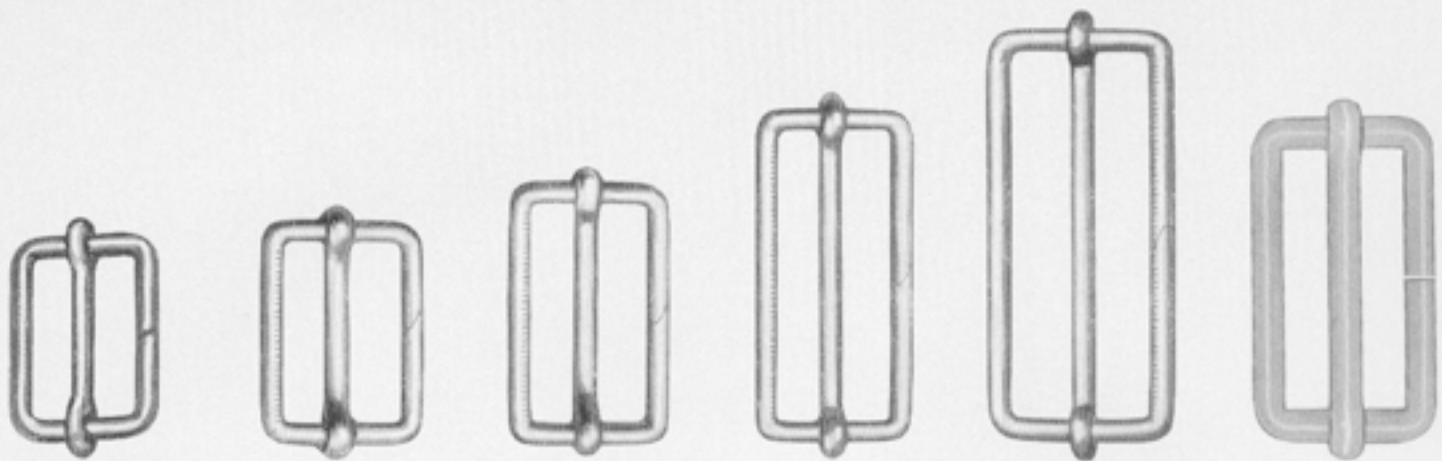

0108
20 mm

0108
25 mm

0108
30 mm

0108
40 mm

0108
50 mm

03228
34 mm

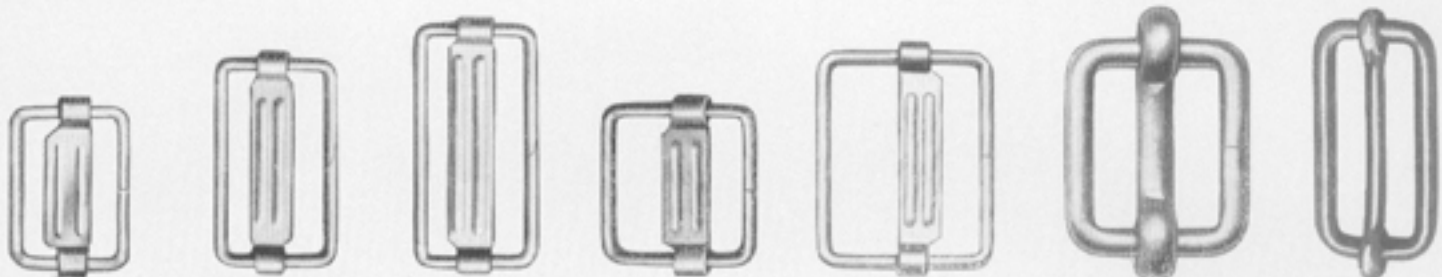

0330
18 mm

0330
25 mm

0330
30 mm

02923
18 mm

02923
25 mm

02835
21 mm

00310
25 mm

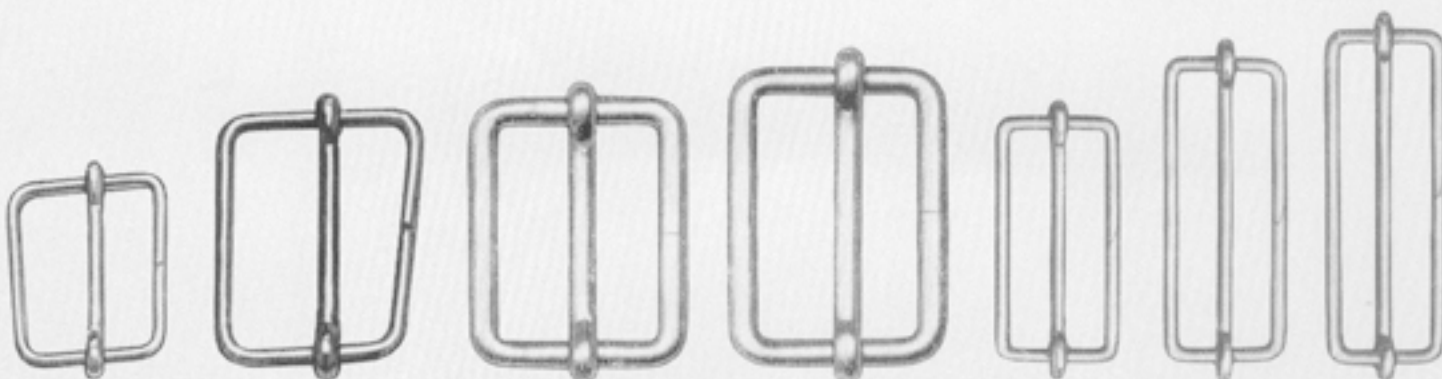

03081
21 mm

03081
29 mm

02868 A
28 mm

02868 A
32 mm

0144
30 mm

0144
38 mm

0144
42 mm

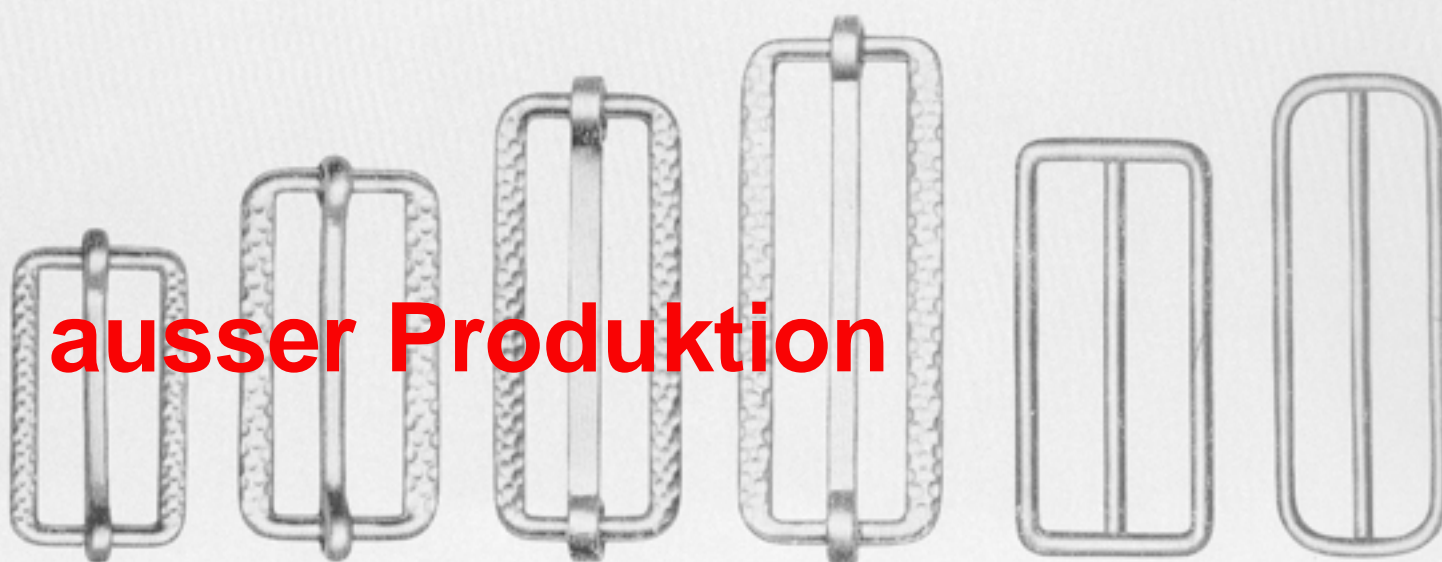

02597
33 mm

02597
40 mm

02597
50 mm

02597
60 mm

02607 B
50 mm

02395
60 mm

ausser Produktion



0108 mit 2 Rollen
50 mm



0108 mit 1 Rolle
40 mm

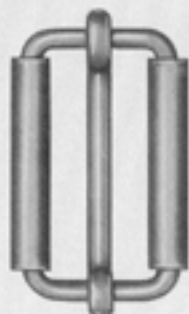

0108 mit 2 Rollen
30 mm

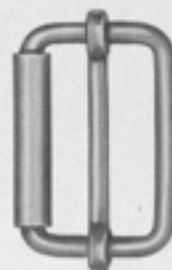

0108 mit 1 Rolle
25 mm



03375
50 mm



03378
50 mm



03378
40 mm



03378
30 mm



03378
25 mm



03378
20 mm



8741
20 mm



8741
25 mm



8741
30 mm



8741
40 mm



03331
21 mm

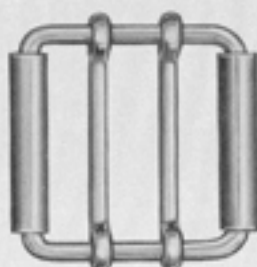

03373
25 mm



03199
30 mm



03199
40 mm



03199
45 mm

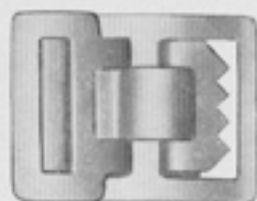

02003
19 mm
ohne Rolle

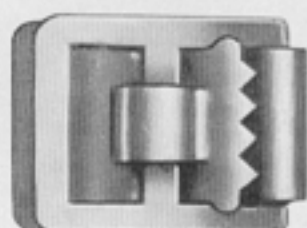

02003
21 mm

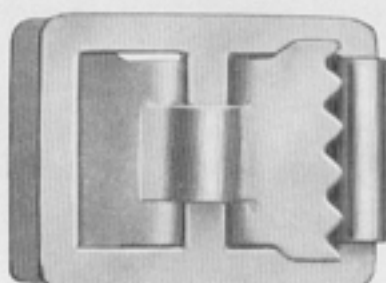

02003
26 mm

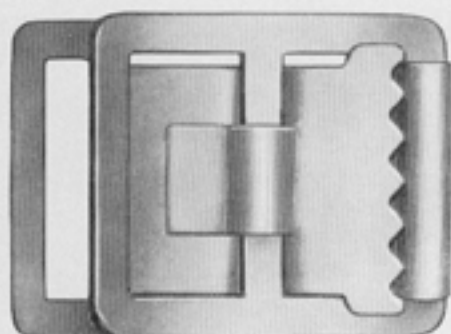

02003
33 mm

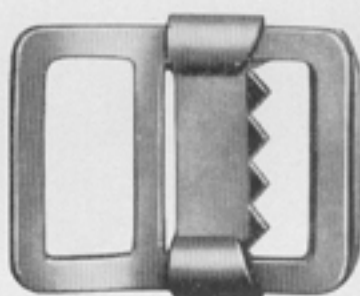

02465
26 mm

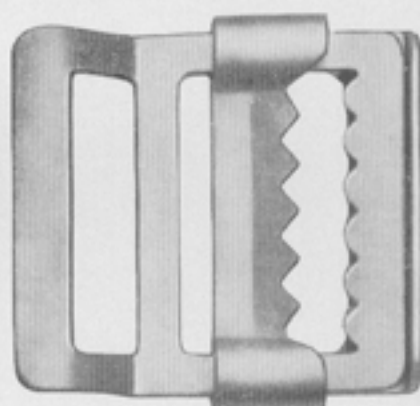

02443
38 mm



02969
17 mm



02968
21 mm

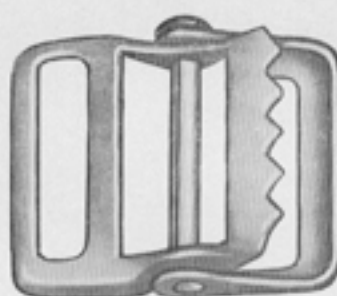

02969
26 mm

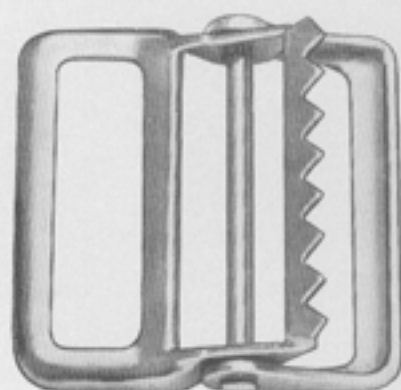

02969
38 mm



03179
15 mm

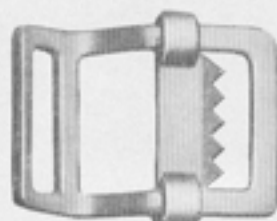

03179
19 mm

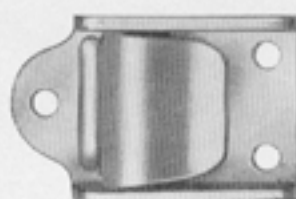

02896 A
20 mm



02896 B
20 mm

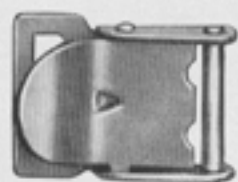

0297 C
17 mm

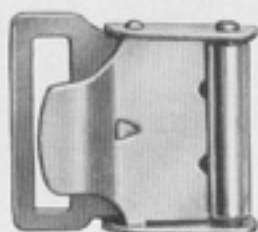

0297 C
25 mm

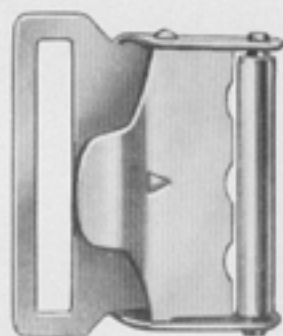

0297 C
36 mm



02866 C
32 mm

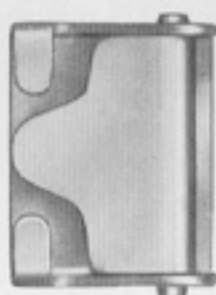

02899 D
32 mm

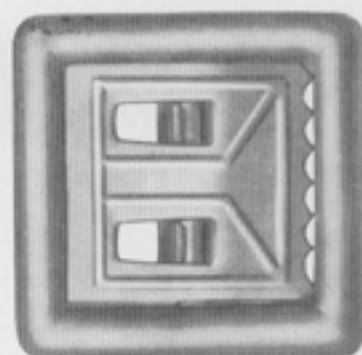

02919
34 mm



02838
8 mm
DIN 7332

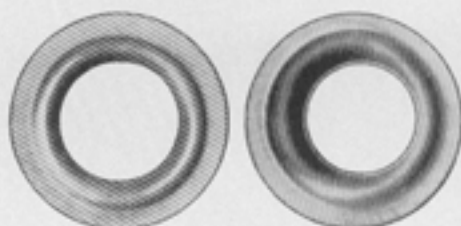

02838
16 mm
DIN 7332

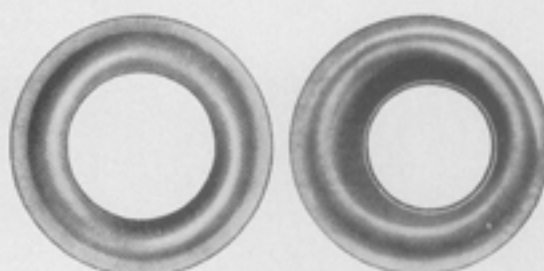

02838
20 mm
DIN 7332



0184
9.5 mm



961
17 mm



0278
23 mm



0183
18 mm



02654 F
17 mm



02711
16 mm



0185
17 mm



0278
17 mm



2254
23 mm



03298
50 mm

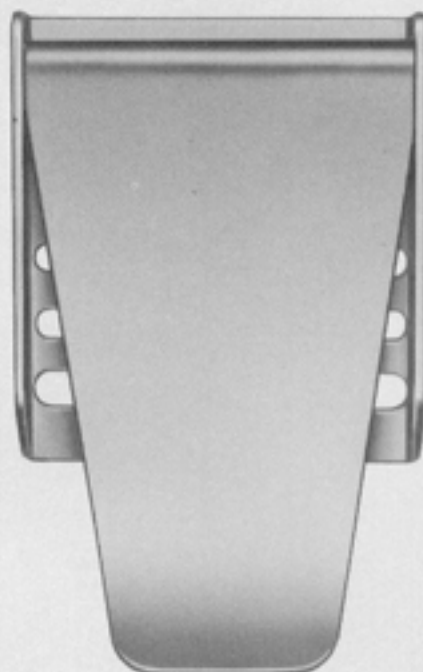

03238
50 mm

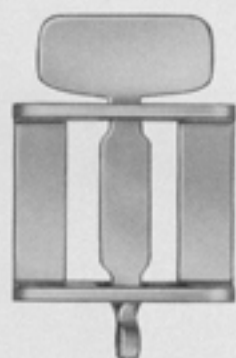

03308
20 mm

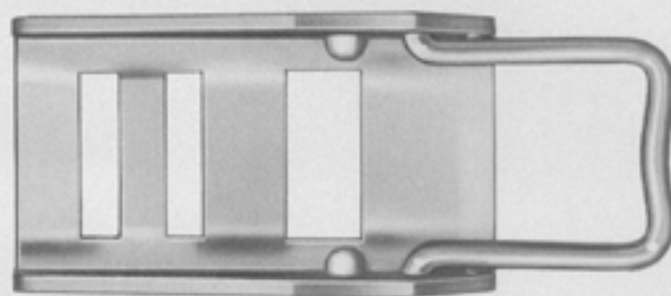

03282
21 mm



03281
48 mm

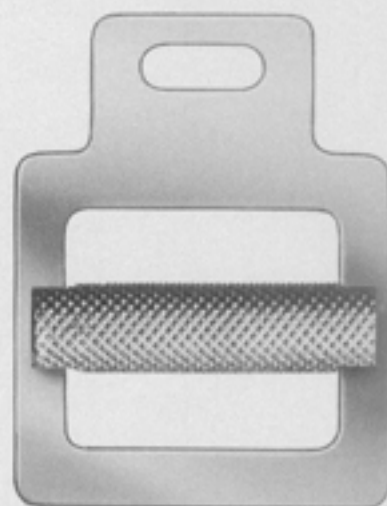

03339
36 mm

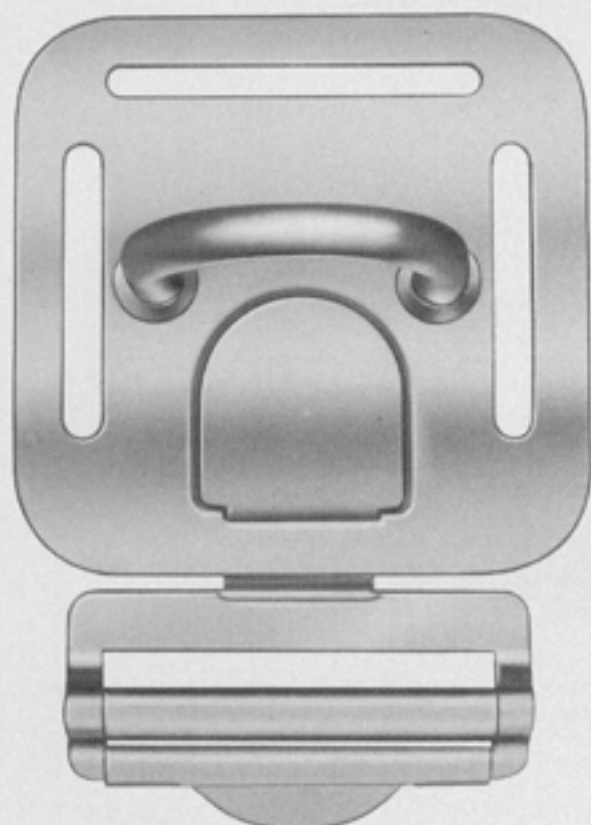

03272
50 mm

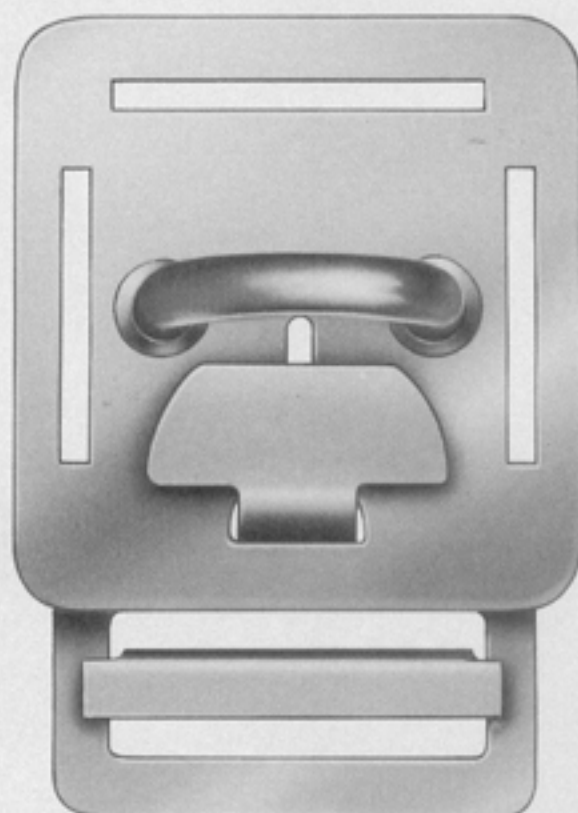

03338
50 mm



03291
50 mm



03237
50 mm



Klappe von 03291

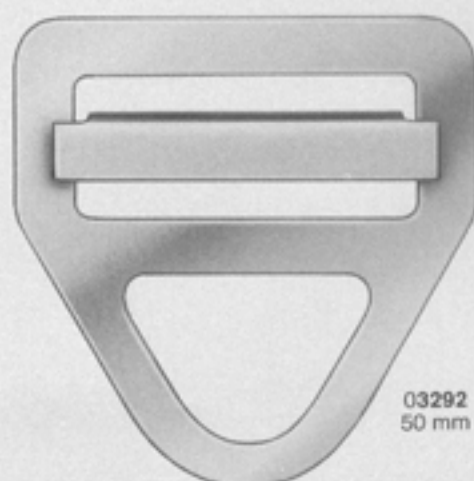

03292
50 mm

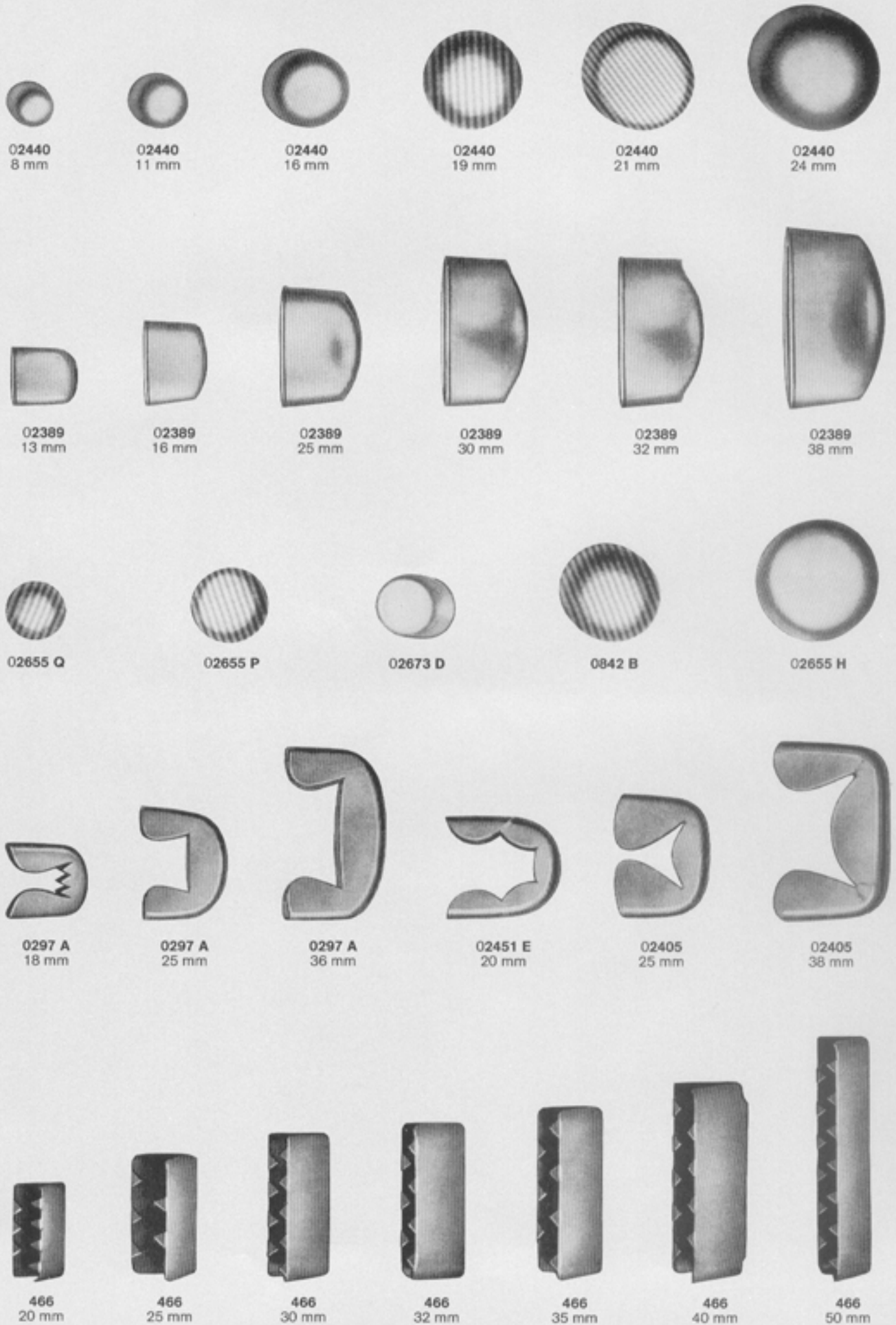

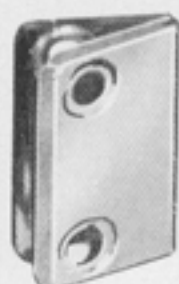
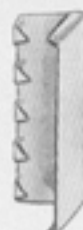
02931
20 mm02931
25 mm02931
32 mm03018
25 mm03018
30 mm03018
40 mm02430 K
25 mm02497
32 mm02497
36 mm02430 E
40 mm0804 C
50 mm02499
54 mm

02538 E

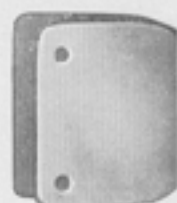
02771
20 mm0465
16 mm0465
20 mm0465
25 mm02538 F
18 mm

02611 B



02611 A

0805 B
58 mm0805 B
58 mm
mit Haken



03050
22 mm



03051
22 mm

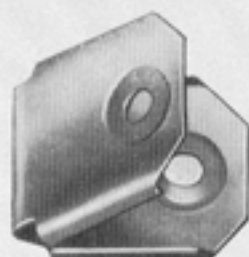

03167
22 mm
Länge 30 mm



03089



03260
27 mm



03168
20 mm



03219
20 mm



03092 mit
0199/16 mm



03352
25 mm



03332
28 mm



03255
32 mm



03090
20 mm



03090
25 mm

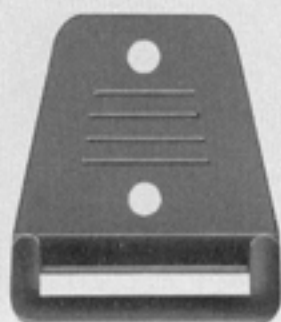

03206
27 mm

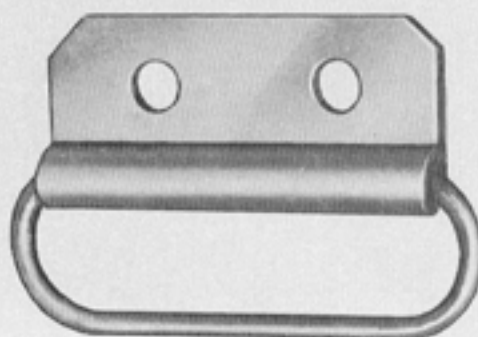

03029
50 mm

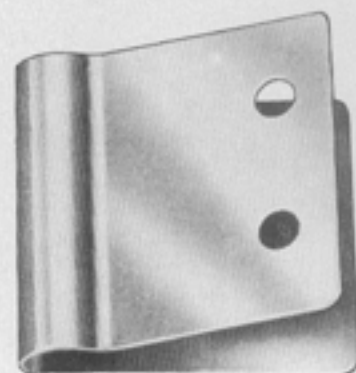

03163
40 mm



02254
25 mm



02254
30 mm



02254
35 mm



02254
40 mm



02254
50 mm



02254
60 mm



02254
70 mm



02616 A
29 mm

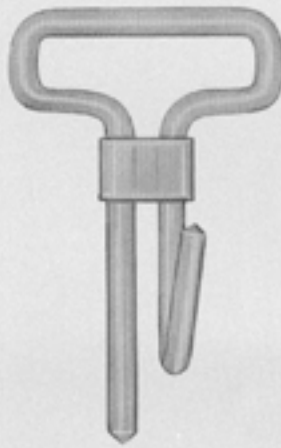

03203 E
30 mm



156
20 mm
02254
40 mm



7427
30 mm
02254
40 mm

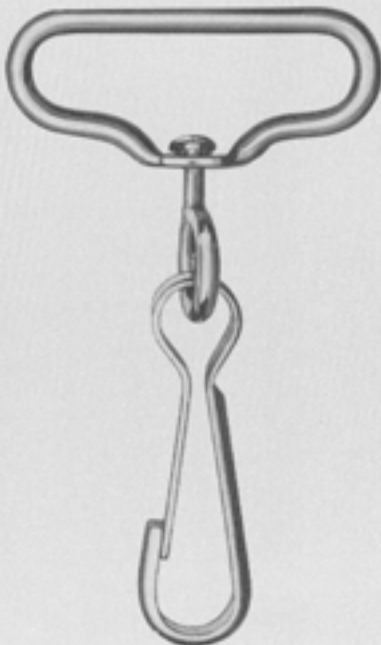

02542
50 x 40 mm

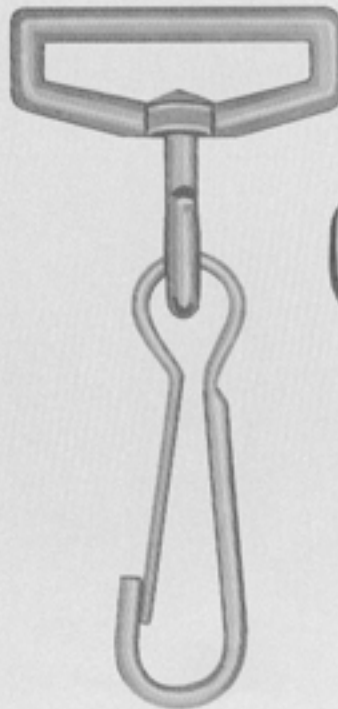

03227
34 mm



02542
40/25 mm

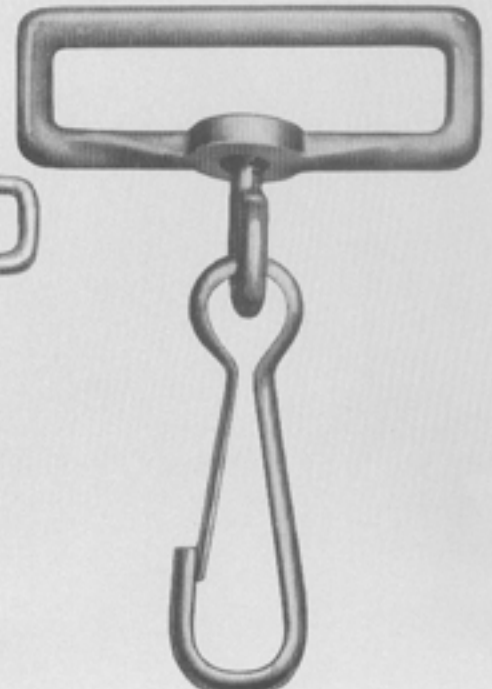

02886 A
60/52 mm



0147
16 mm



0147
18 mm



0147
20 mm



0147
24 mm

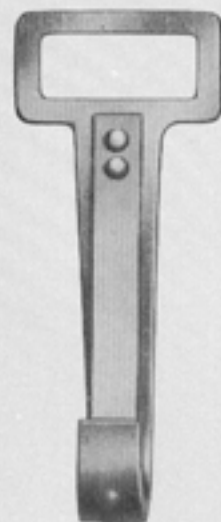

02602 G
20 mm



0425 A
40/16 mm



0425 A
50/20 mm



0204
40 mm

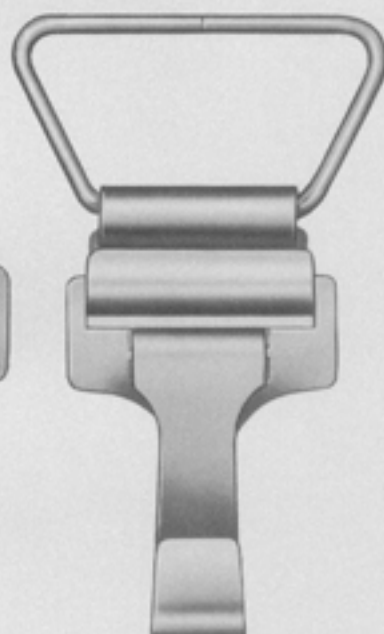

03266
40 mm



0230
18 mm



0349
20 mm



0240
20 mm



0204
20 mm
mit Rolle

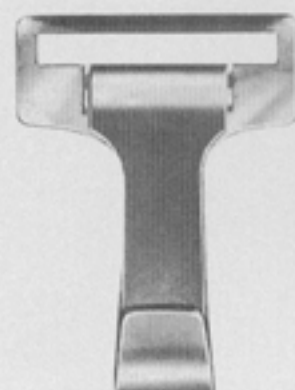

0204
30 mm



0155
25 mm

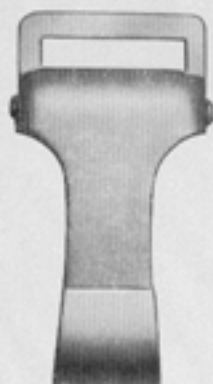

0155
02611 M
20 mm



03152
20 mm
gekörnt



0454 C



02673 A
20 mm

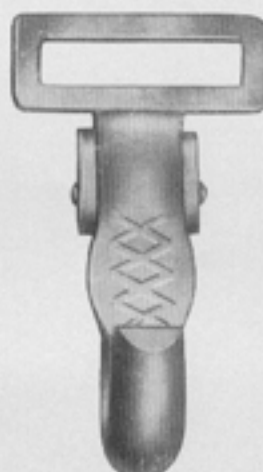

02655 N
26 mm

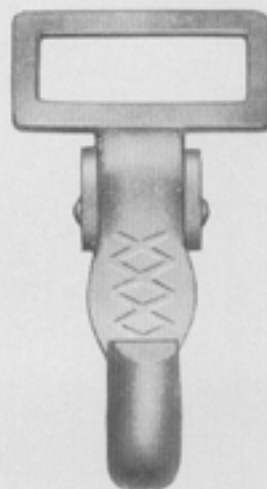

02774
27 mm

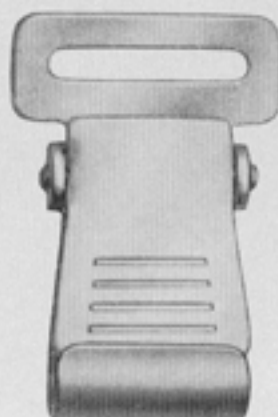

02875
27 mm



02893 A 2
21 mm

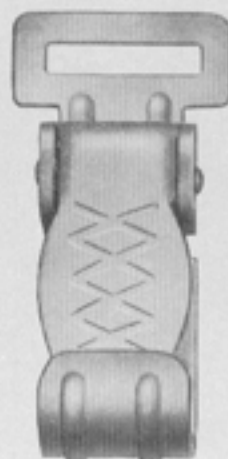

02823 B
20 mm

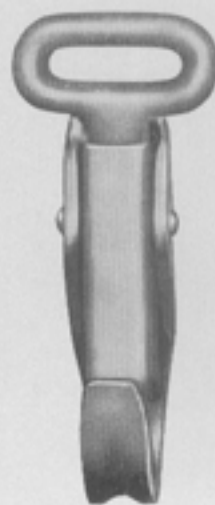

02885 A
20 mm
+ 30 mm

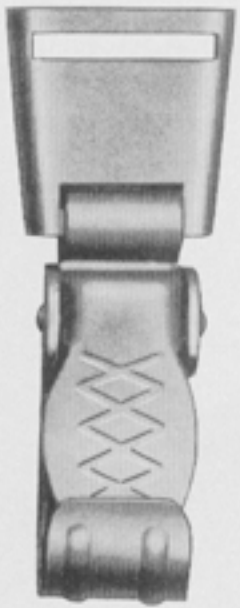

02866 B
25 mm

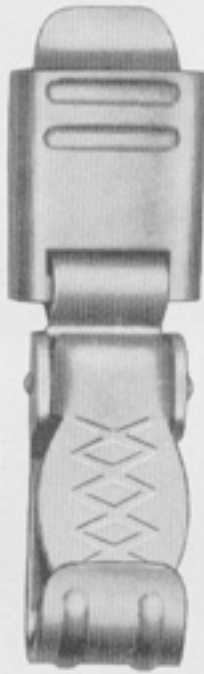

02893 A 1
21 mm

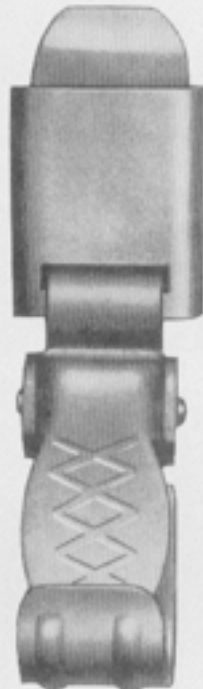

02866 A
25 mm

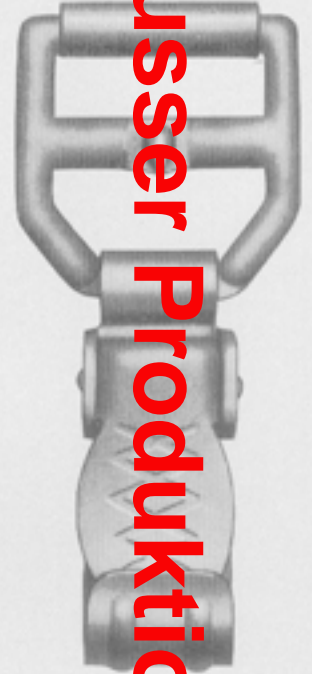

02911 A
28 mm

ausser Produktion

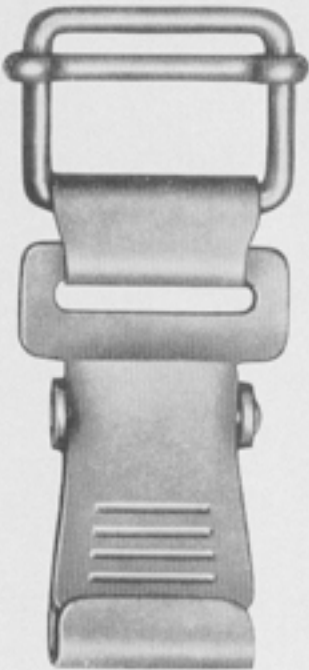

02953
28 mm

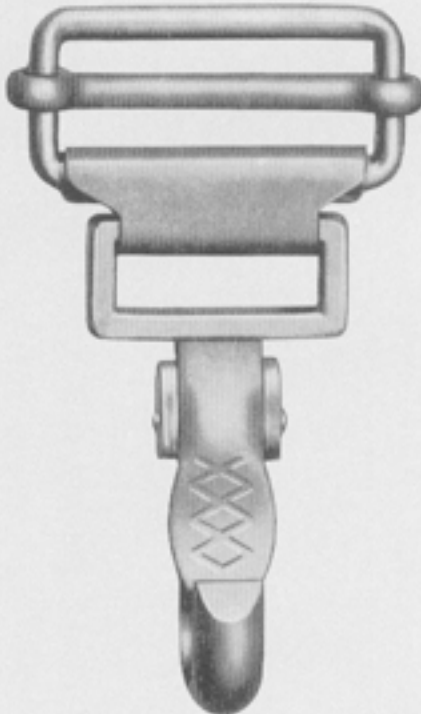

02925 H
42 mm

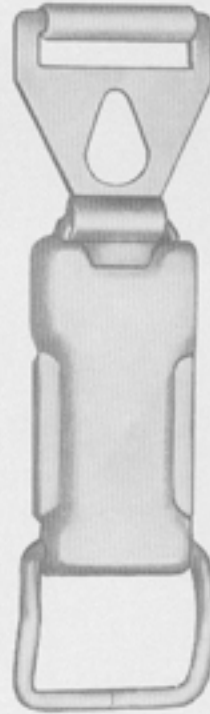

03054 A

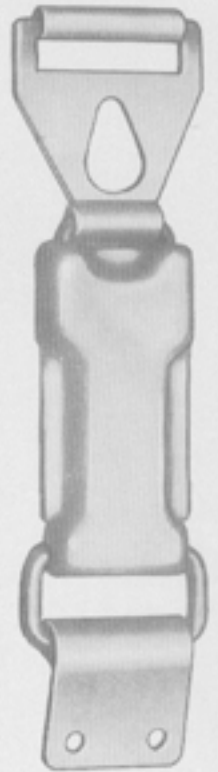

03053 A

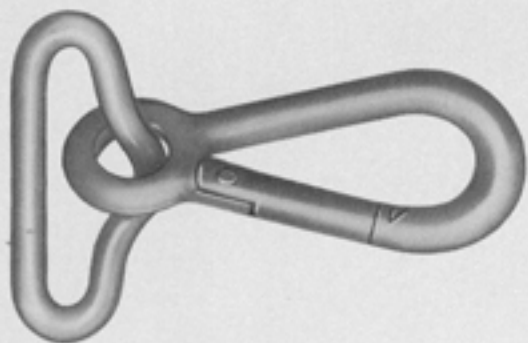

03299 A
32 mm

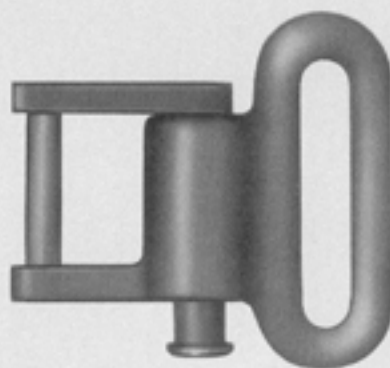

03299 B
32 mm

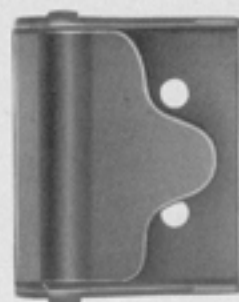

03299 C
32 mm

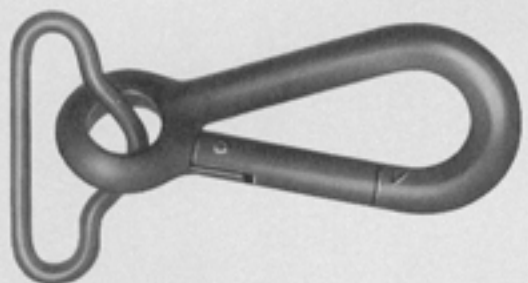

03080 B
26 mm

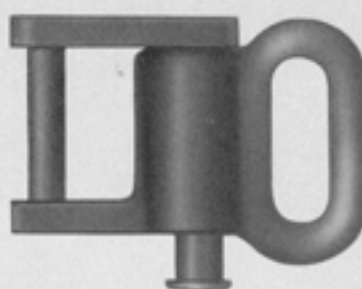

03080 A
21 mm

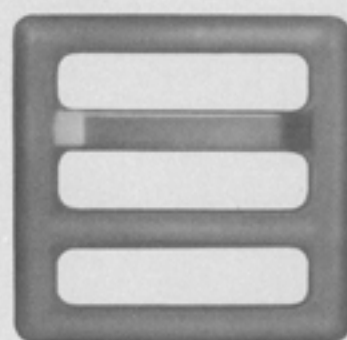

03299 D
33 mm



03305
35 mm

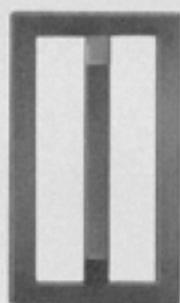

03309
32 mm



03329
31 mm

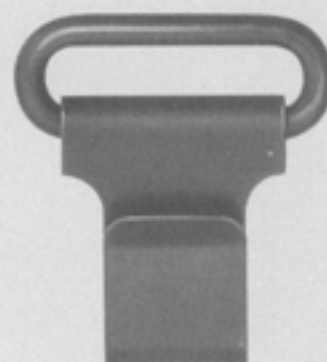

03345
32 mm

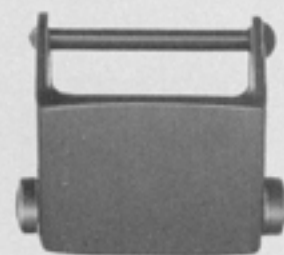

02298 dünne Rolle
03334 dicke Rolle

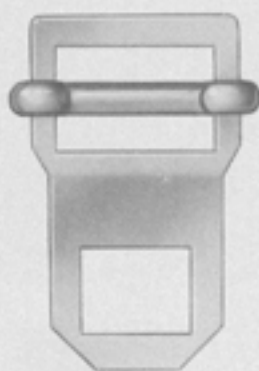

03356
21 mm



03343
34 mm



03155
26 mm



03155 + 03361
29 mm

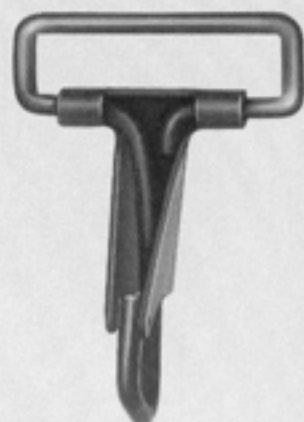

03155
32 mm



03349
26 mm



03349
29 mm

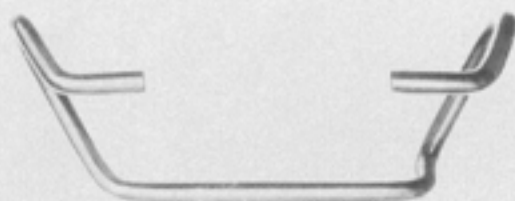

03278



02866 A
25 mm

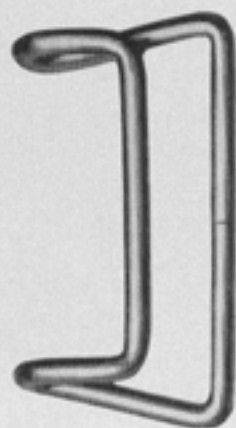

02805
50 mm



03257

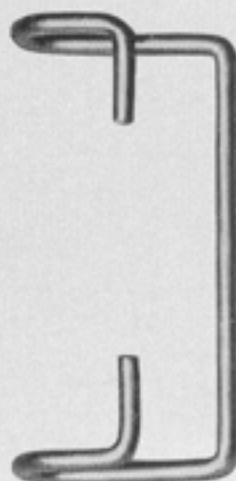

0816



02610



02606

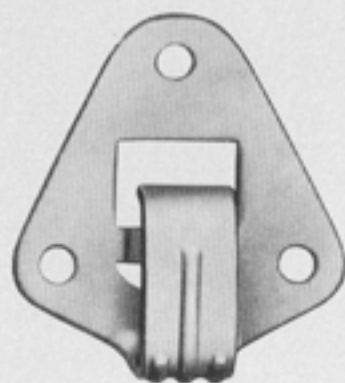

02879

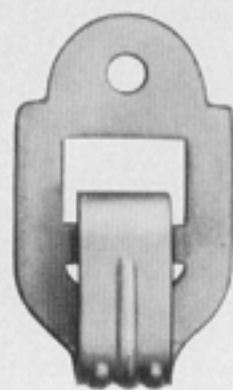

02851 C

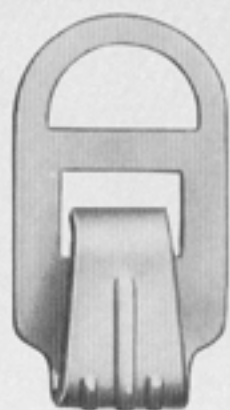

02893 D

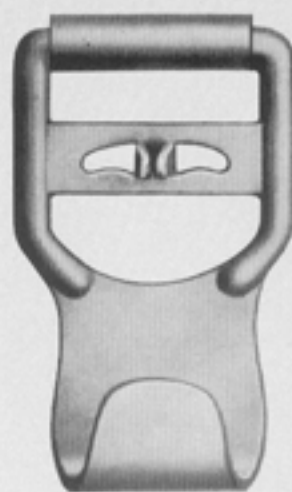

02882
28 mm

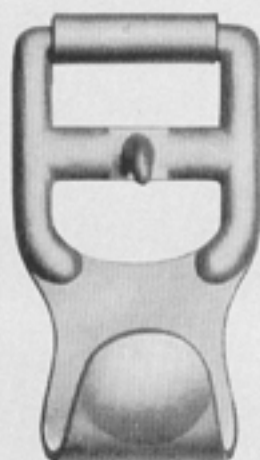

0399 A
22 mm

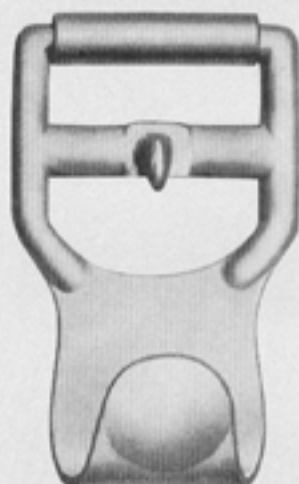

02602 F
26 mm

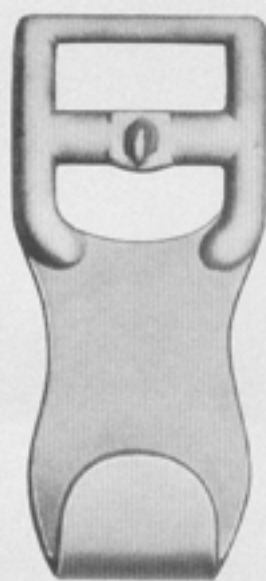

0399 B + 02813 B
22 mm

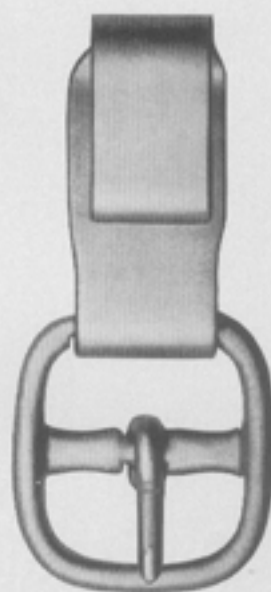

02035
26 mm



02893 B



03236



02854

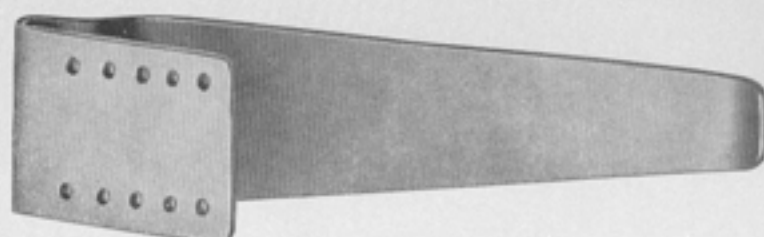

02962

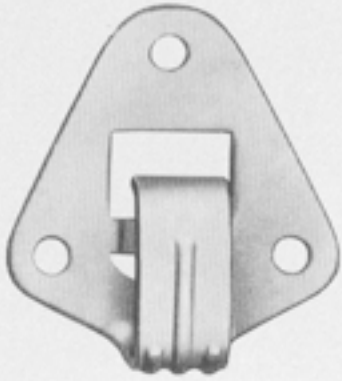

02879



02851 C

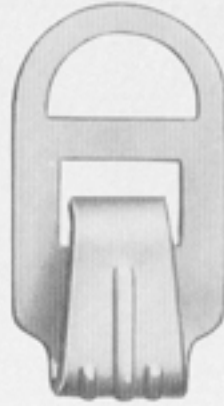

02893 D



02892
26 mm

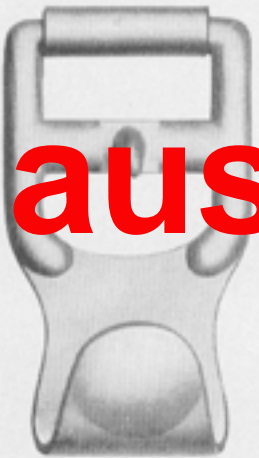

0399 A
22 mm

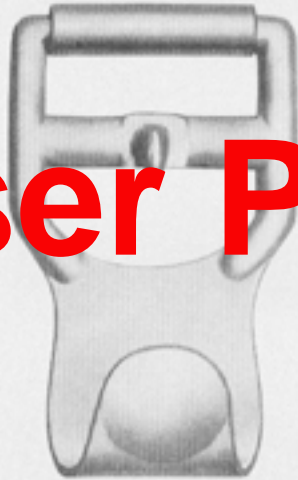

02602 F
26 mm

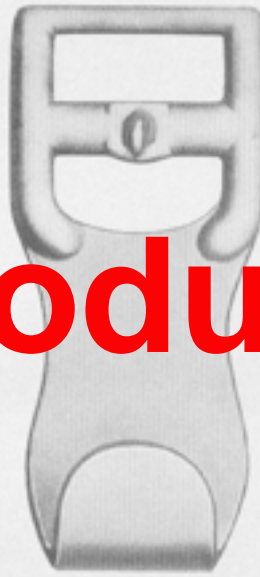

0399 B + 02813 B
22 mm

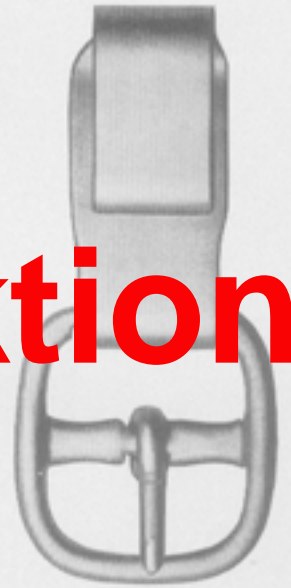

02035
26 mm



02893 B



03236



02854

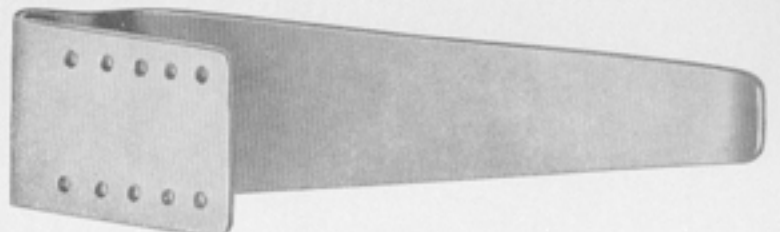

02962

ausser Produktion

ausser Produktion



02183
18 mm



00235
18 mm



0190



02464



02302



03182
16,5 mm



664 +
W 2211



1091



02397 B



02817
22 mm



0657



02529



02035 H



0455 C

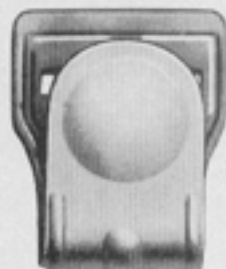

0483 A
20 mm



02430 G
25 mm

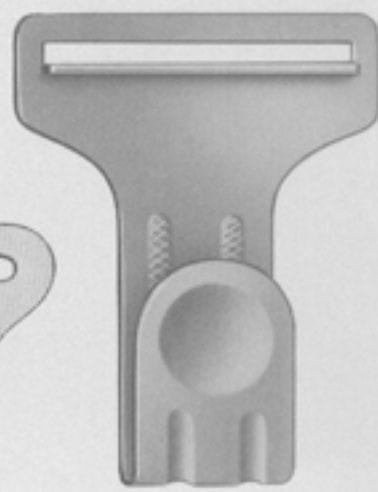

03263
40 mm



02861 A



02861 C



02757 A



02757 B



02886 B



02733 A
15 mm



02821
15 mm



02930

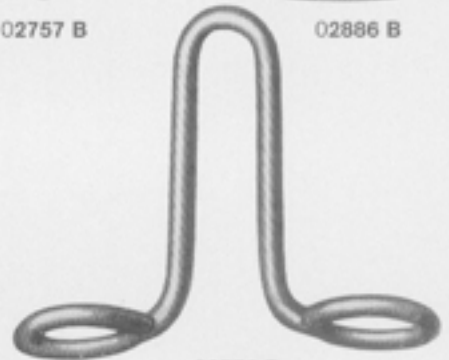

02756 B

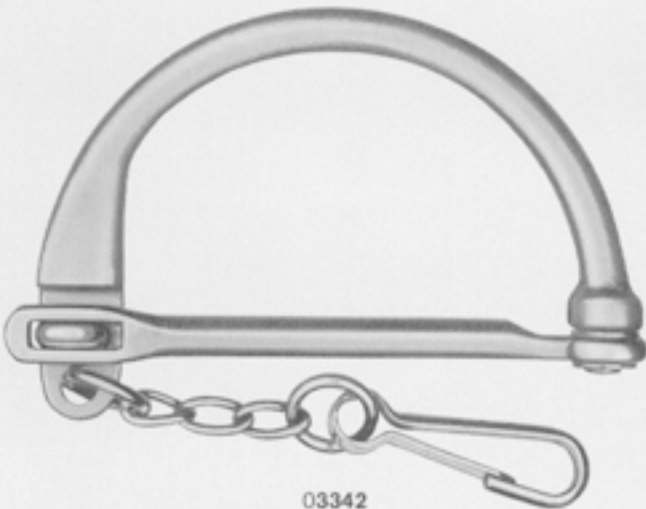

03342
½ natürl. Größe

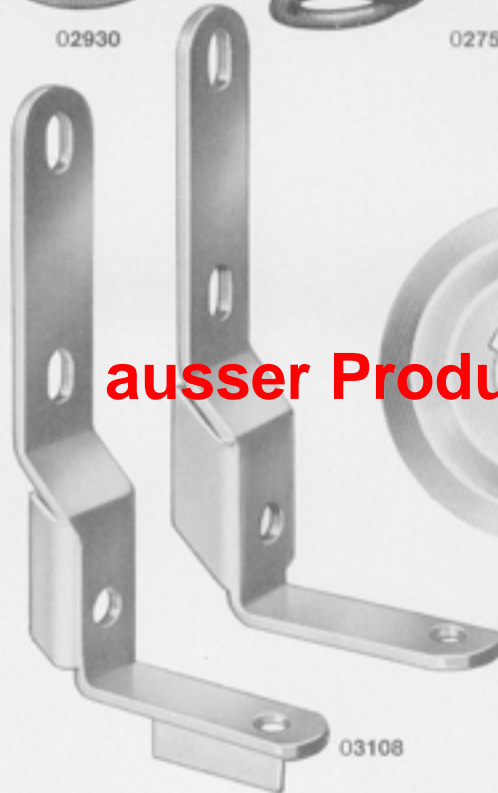

03107



03210

ausser Produktion



02944 E
21 mm



02827



03054 B



8882
15 mm



02733 D
23 mm



02781
33 mm



02782
33 mm



02622 C



02622 A



02622 D



02790 A
16 mm



02704 E



02704 B
28 mm



02704 A



02622 B1



02622 B



02622 E



02952 B



02704 C



02704 CP



02704 DR



02463 A + B



02881 A



03010 A



03010 C



02881 B

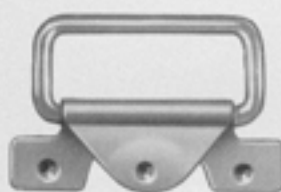

03379



03359
19,5 mm



02890



03365



02820



0441 B



0149



0483 C



02344



02035 L



02851 E



8 x 5



8 x 7



0337 B



0307



10 x 7



10 x 5



0462 L



02898 C



02885 C



0259



02864 D



02397 H



0280 F



0280 E



03354



03231



03146



03194



03297



03145



ausser Produktion

03117

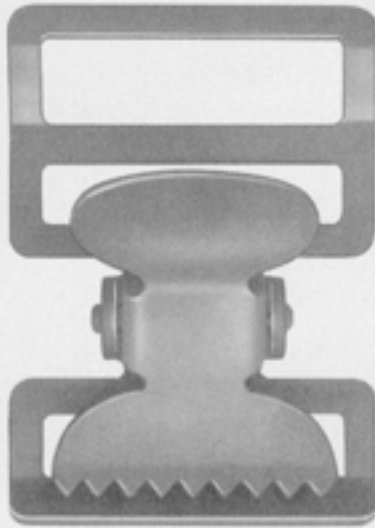

03347
40 mm

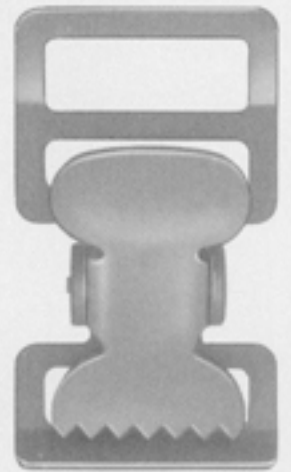

03347
27 mm



03183



03363

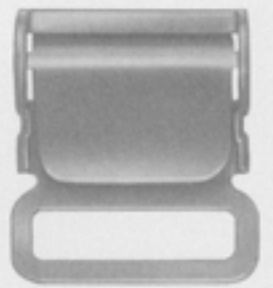

03302
28 mm



03193



03328



03221

ausser Produktion



03232

Prüfen 25 und 55°



03293

ausser Produktion



03266

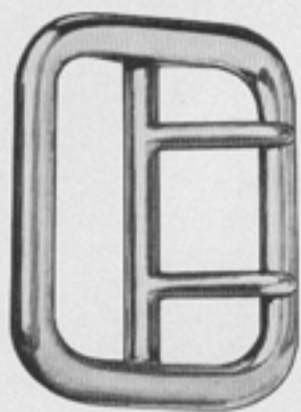

0581
40 mm

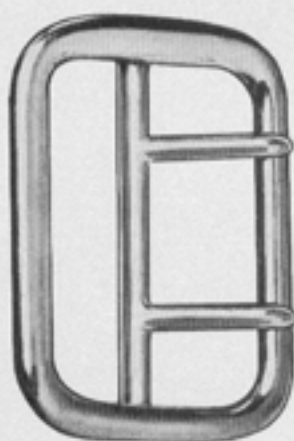

0581
45 mm

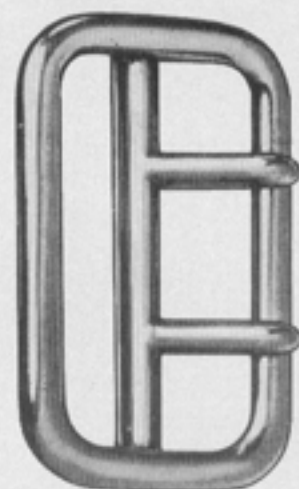

0581
52 mm

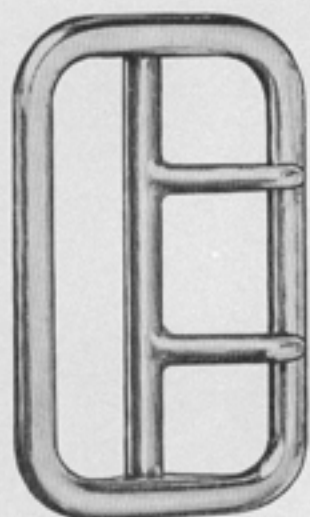

0581
55 mm

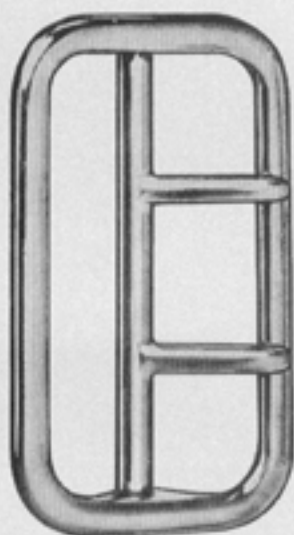

0581
58 mm



0581
62 mm

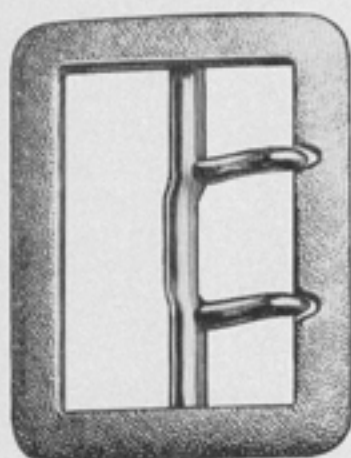

0755
45 mm

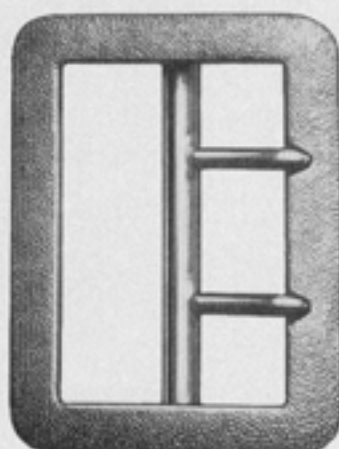

0644
45 mm

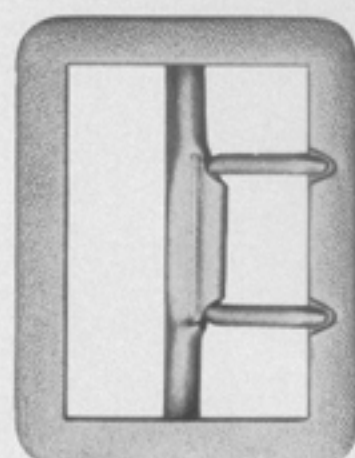

0822
45 mm

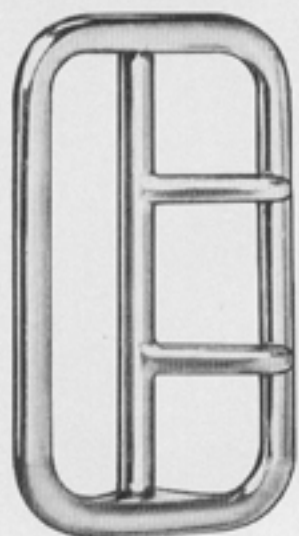

A/58 mm

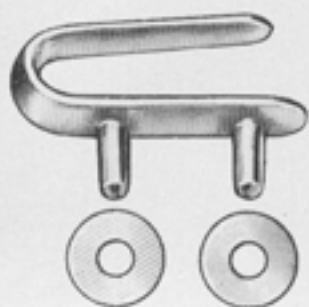

B



C



D/25 mm



E/25 mm



F/25 mm



G



H

02397

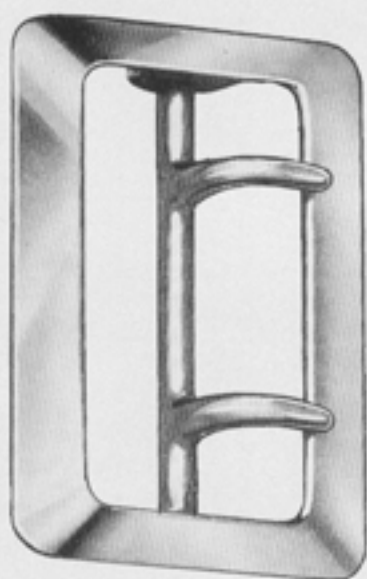

A/58 mm

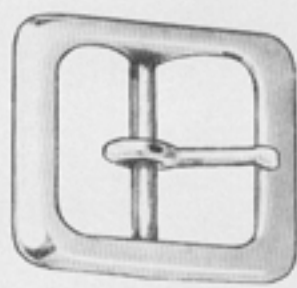

B



F



D



E



C

03087

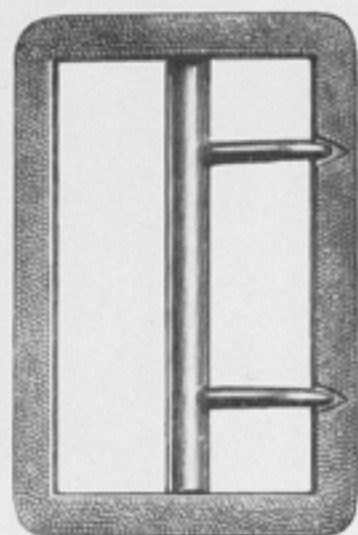

0666
55 mm

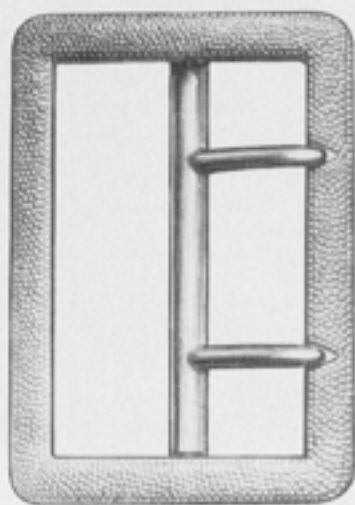

0666
50 mm

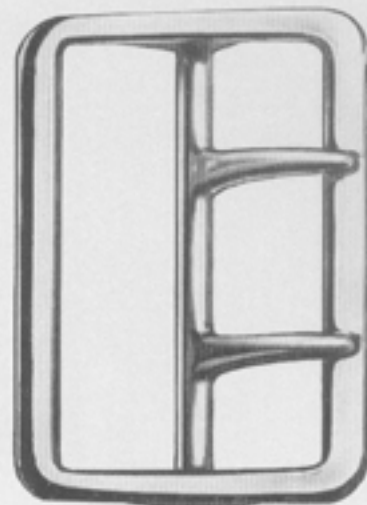

0836
57 mm

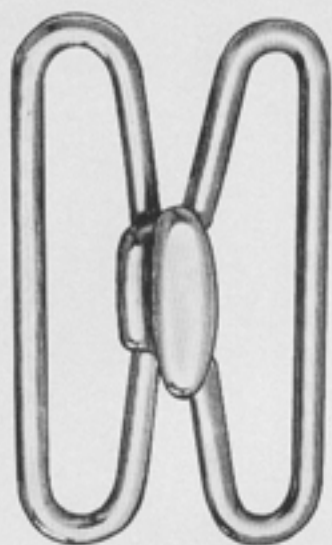

0799 A
60 mm

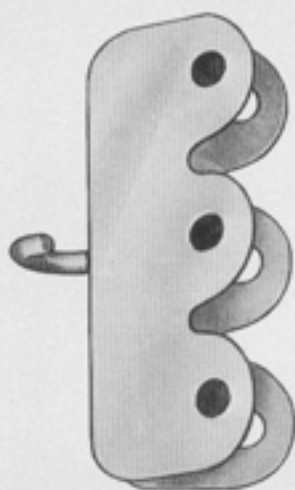

0799 B
59 mm



0799 C
58 mm

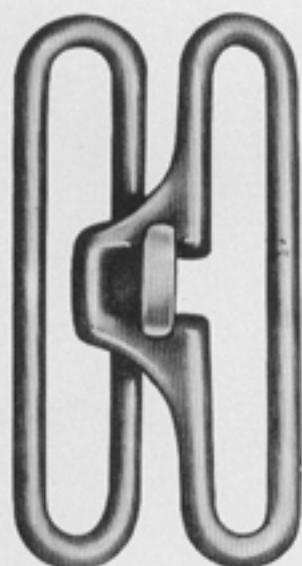

0805 A
60 mm

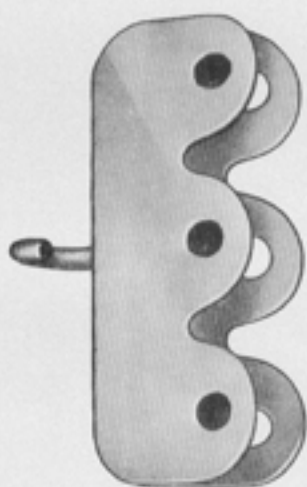

0805 B
59 mm



0805 C
57 mm

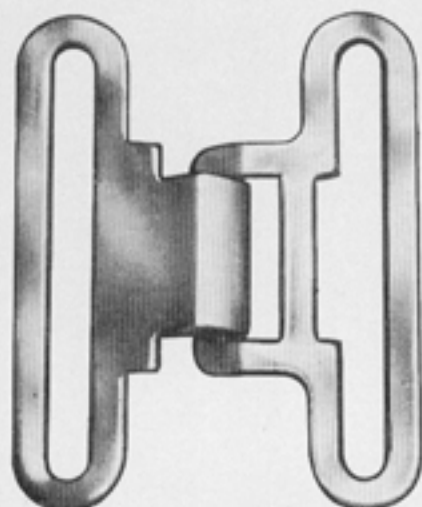

0808 A
57 mm

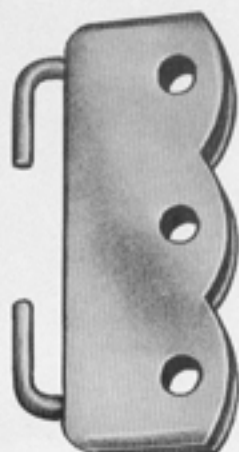

0808 B
56 mm



0808 C
57 mm





0976
40 mm



0862
40 mm

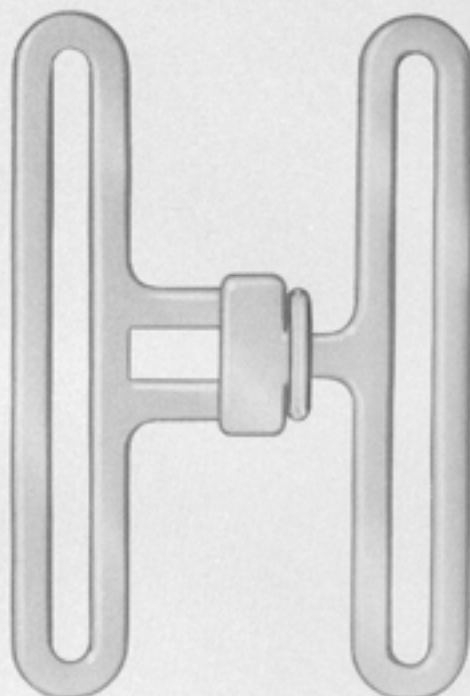

03324
80 mm



466
32 mm

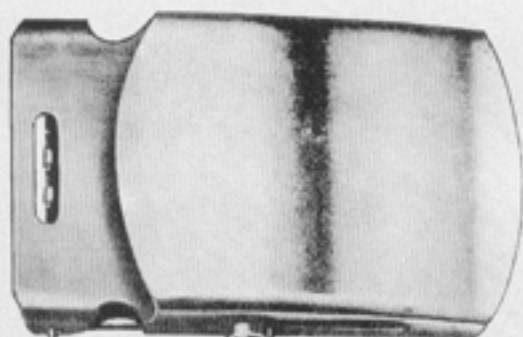

0885
35 mm



03018
30 mm

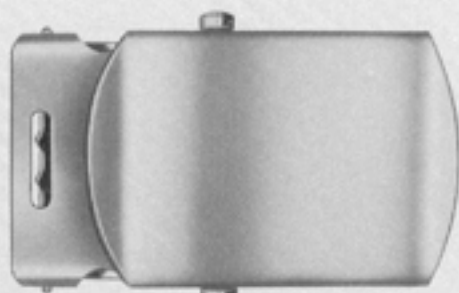

0885
30 mm



466
20 mm



0885
20 mm

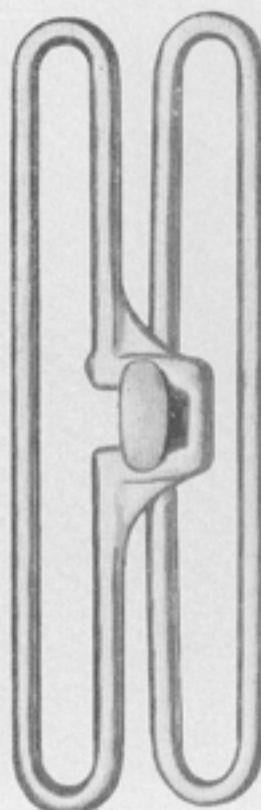

0804 A
97 mm



0778
45 mm



0779
45 mm



0785
45 mm



0984
45 mm



0739
35 mm



2980

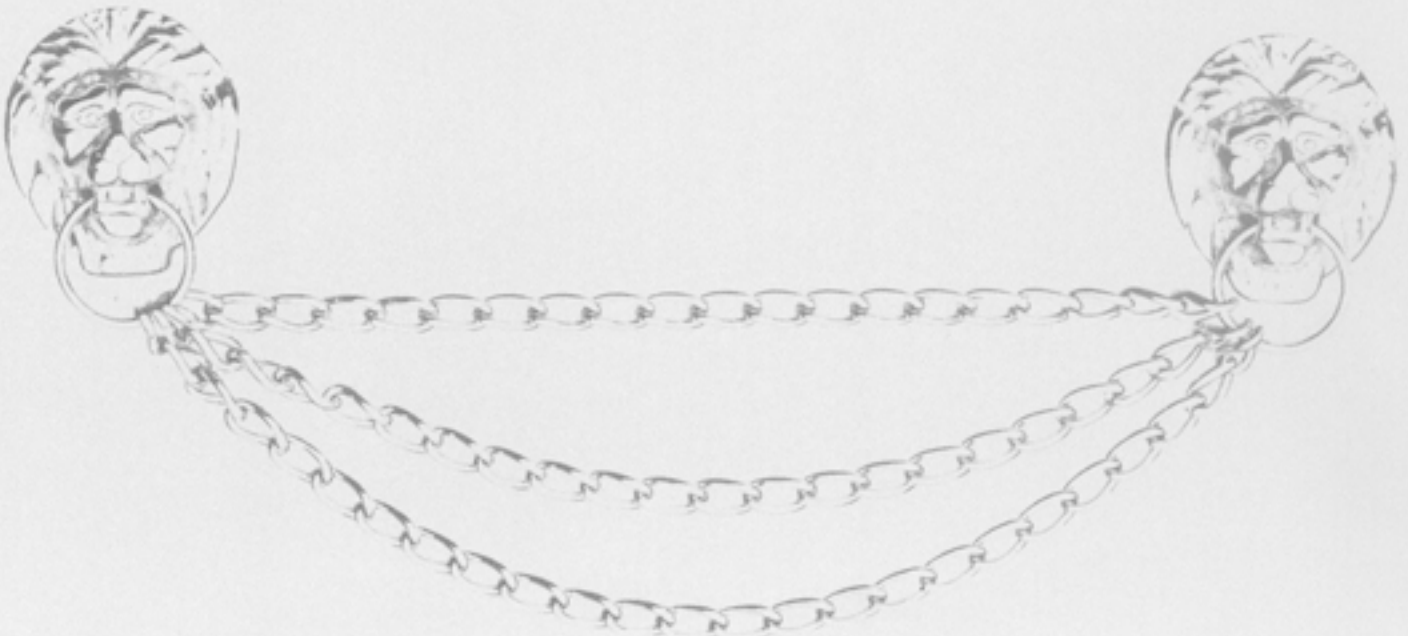

0966
45 mm

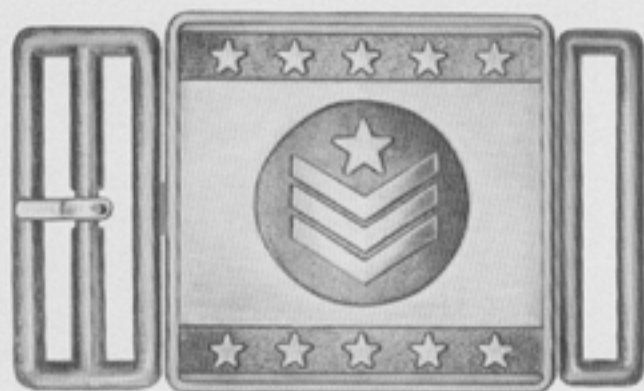

0963
40 mm

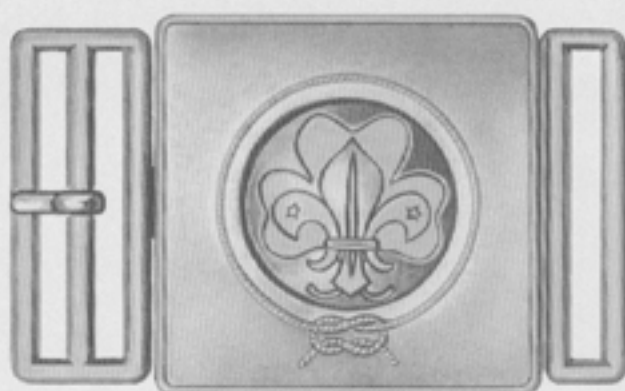

0959
40 mm

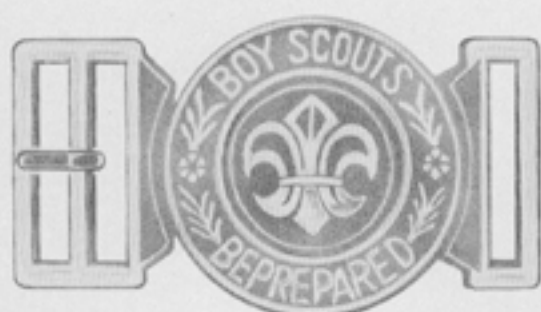

0833
25 mm



0833
30 mm



0960
37 mm



0962
37 mm



0964
35 mm



0961
35 mm

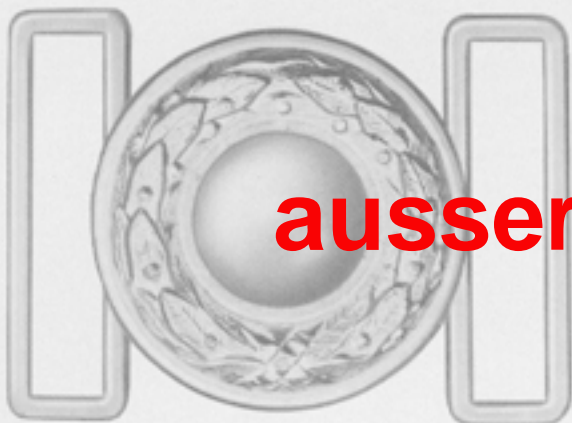

0788
45 + 50 mm



0741
45 mm
mit Auflage 1675

ausser Produktion



0835
30 mm



0849
30 mm



0898
30 mm

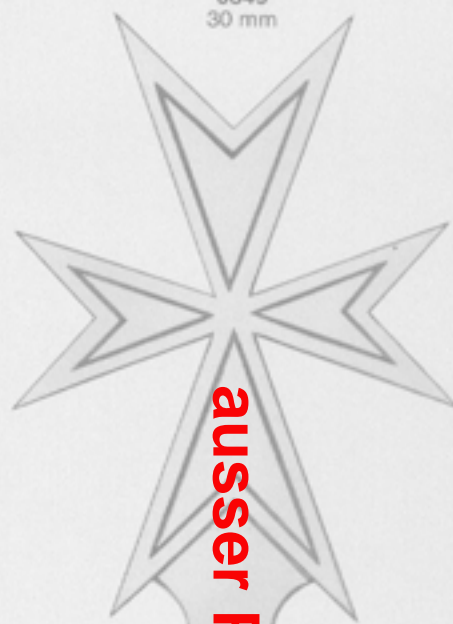

ausser Produktion



0576
45 mm

Bannerspitze
(1/3 natürl. Größe)



0522
45 mm



0535
45 mm



0522 mit Lyra 1509
45 mm



0787
45 mm



0769
45 mm



0819
45 mm



0743
45 mm



V 45



B 45



B 35

ausser Produktion



0878 A
50 mm



B



C

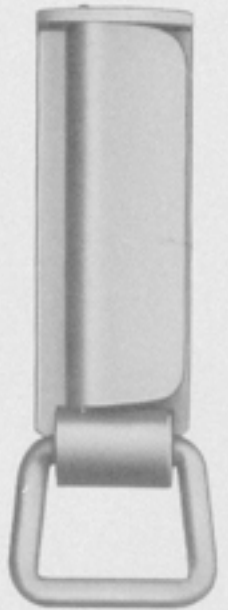

02878
50 mm



02982 A
32 mm



0889
50 mm

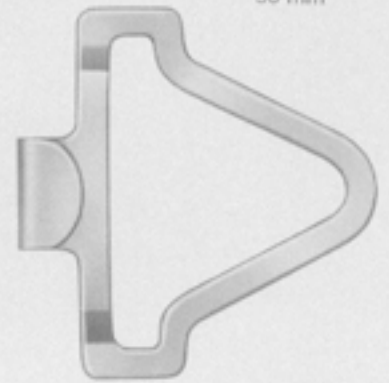

Z/50 mm

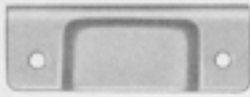

B

Uniformeffekten · Effects on uniforms · Effets pour uniformes · Efectos para uniformes

