

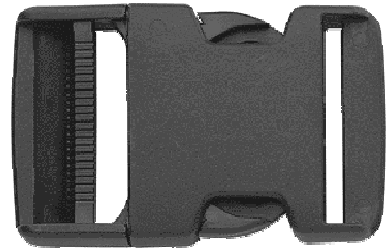

## STECKVERSCHLUSS

9000

Grösse	Nylon	Polypropylen	Acetal
10 mm	●		●
16 mm	●		●
20 mm	●	●	●
25 mm	●	●	●
30 mm	●	●	●
40 mm	●	●	●
50 mm	●		●



## STECKVERSCHLUSS

9001

Grösse	Nylon	Polypropylen	Acetal
40 mm	●		●



## STECKVERSCHLUSS

gebogen

9002

Grösse	Nylon	Polypropylen	Acetal
12 mm	●		●
16 mm	●		●
20 mm	●		●
25 mm	●		●





## STECKVERSCHLUSS

9003

Grösse	Nylon	Polypropylen	Acetal
25 mm	●		●
35 mm	●		●

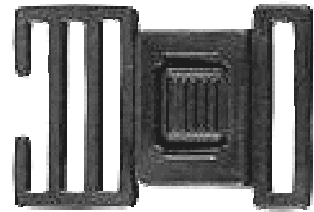

## KLEMMSCHNALLE

9004

Grösse	Nylon	Polypropylen	Acetal
25 mm	●		
35 mm	●		●

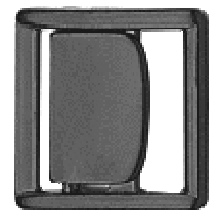

## KLEMMSCHNALLE

9005

Grösse	Nylon	Polypropylen	Acetal
16 mm	●		
20 mm	●		
25 mm (starke Ausführung)	●		●
30 mm	●		
40 mm			●
50 mm	●		





## SCHIEBER

9007

Grösse	Nylon	Polypropylen	Acetal
20 mm	●	●	●
25 mm	●	●	●
30 mm	●	●	●
40 mm	●	●	●
50 mm	●		●

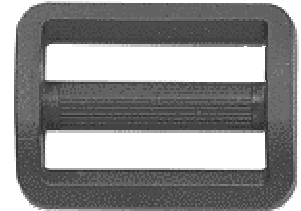

## LEITERSCHIEBER

9008

Grösse	Nylon	Polypropylen	Acetal
16 mm	●		●
20 mm	●	●	●
25 mm	●	●	●
30 mm	●	●	●
40 mm	●		



## KARABINERHAKEN

9011

Grösse	Nylon	Polypropylen	Acetal
20 mm	●	●	●
25 mm	●	●	●
30 mm	●	●	●
40 mm	●	●	●
50 mm	●		●

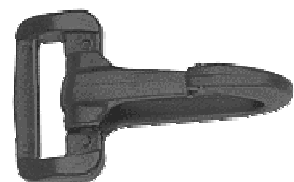



## KARABINERHAKEN

9010

wie 9012, jedoch mit feststehendem Wirbel

Grösse	Nylon	Polypropylen	Acetal
16 mm	●	●	●

## KARABINERHAKEN

mit drehbarem Wirbel

9012

Grösse	Nylon	Polypropylen	Acetal
16 mm			●



## KARABINERHAKEN

mit drehbarem Wirbel

9013

Grösse	Nylon	Polypropylen	Acetal
20 mm			●
25 mm			●
30 mm			●
40 mm			●
50 mm			●

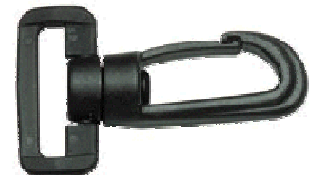

## HAKEN

9014

Grösse	Nylon	Polypropylen	Acetal
48x15 mm	●	●	●





## HAKEN

9015

Grösse Nylon Polypropylen Acetal



## HAKEN

9016

Grösse Nylon Polypropylen Acetal

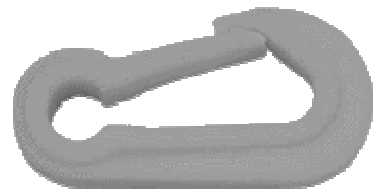

## KARABINERHAKEN

9025

Grösse Nylon Polypropylen Acetal

30 mm



## SCHLAUFE

breit

9024

Grösse Nylon Polypropylen Acetal

16 mm ●

20 mm ●

25 mm ●





## SCHLAUFE

9017

Grösse	Nylon	Polypropylen	Acetal
20 mm	●	●	●
25 mm	●	●	●
30 mm	●	●	●
40 mm	●	●	●
50 mm	●	●	●



## HALBRING

9018

Grösse	Nylon	Polypropylen	Acetal
16 mm	●		
20 mm	●	●	●
25 mm	●	●	●
30 mm	●	●	●
40 mm	●	●	●
50 mm	●		



## DREIECKRING

9019

Grösse	Nylon	Polypropylen	Acetal
20 mm	●		●
25 mm	●		●
30 mm	●		●
40 mm	●		●





## 3-WEGE SCHLIESSE

9029

Grösse	Nylon	Polypropylen	Acetal
25 mm	●		



## STECKVERSCHLUSS

9020

Grösse	Nylon	Polypropylen	Acetal
40 mm			●

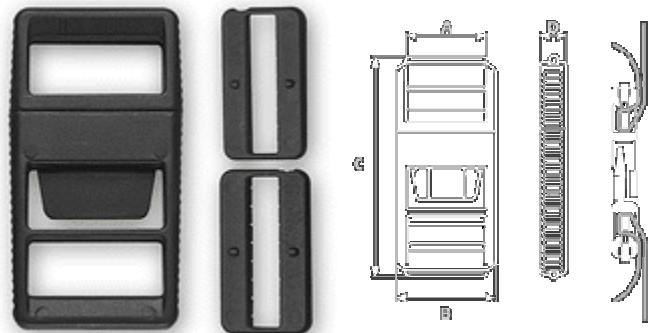

## SCHIEBER

9021

Grösse	Nylon	Polypropylen	Acetal
10 mm	●		
16 mm	●		



## SCHIEBER

9022

wie 9007

Grösse	Nylon	Polypropylen	Acetal
10 mm	●		●
16 mm	●		●



# KARABINERHAKEN

## 9023

Grösse	Nylon	Polypropylen	Acetal
5 mm	●		
8 mm	●		

